

WR112(BJ84) Waveguide Termination, RWT112600 6.57-9.9GHz, 600W, FBP84(UBR) Flange, Rectangular

Dimensions(mm) Tolerance $\pm 1\%$

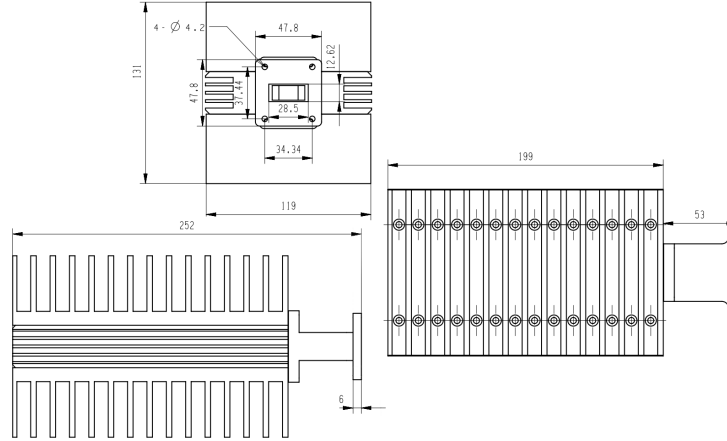

Electrical & Environmental

Frequency Range	6.57-9.9GHz	Impedance	50 ohm	VSWR	1.2 max
Input Avg Power	600W @25°C	Peak Power	-		

Mechanical & Product Information

Product Number	RWT112600, Professional	Waveguide/Flange	WR112(BJ84), FBP84(UBR) Flange
Waveguide Body	Aluminum, black painted	Heat Sink	Black anodized aluminum
Waveguide Cavity	Aluminum, electric conductive oxidation		
Operating Temp		Net Weight	-

Typical Test Data

Notes

1. Customized outlines and optimal VSWR available.
2. Refer to the derating curve for power input, derate linearly to 60W at 100°C.
3. To maintain best performance, recommended to use fan to keep the case temp under 85°C.

