

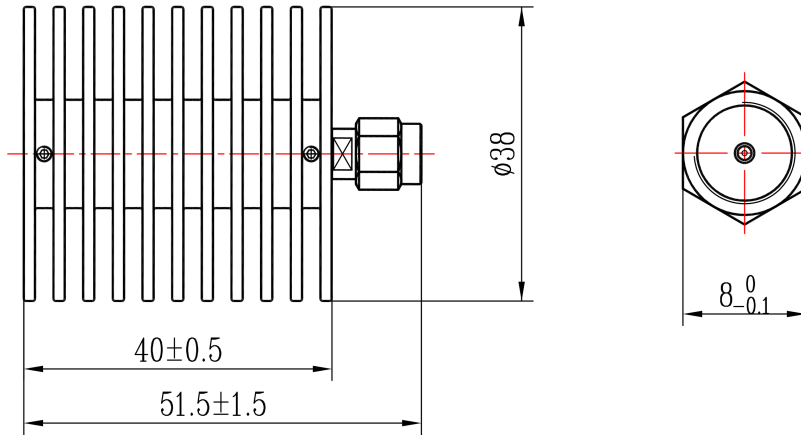

SMA Male Coaxial Termination, RT625SM DC-6GHz, 25W, Round

Dimensions(mm) Tolerance±1%



Electrical & Environmental

Frequency Range	DC-6GHz	Impedance	50 ohm	VSWR	1.2 max
Input Avg Power	25W @25°C	Peak Power	500W (5μsec pulse width, 2.5% duty cycle)		

Mechanical & Product Information

Product Number	RT625SM, P-Grade	Connector	SMA Male
Connector Body	Passivated stainless steel	Heat Sink	Black anodized aluminum
Center Contact	Gold plated phosphor copper		
Operating Temp	-55°C~+125°C	Net Weight	-

1. Customized connectors, dimensions, PIM, VSWR.
2. Refer to the RFTOP Termination selection and usage guide.

Notes: To ensure longevity and performance, do not use at full power for a long time. Peak power, pulse width, and duty cycle need to meet the requirements. Input high power, require heat dissipation, maintain temperature within 60°C. Reference Curve, derate linearly to 3W at 100°C.

