

## 2.4mm Female Coaxial Termination, RT5035F DC-50GHz, 35W, Round

### Dimensions(mm) Tolerance±1%

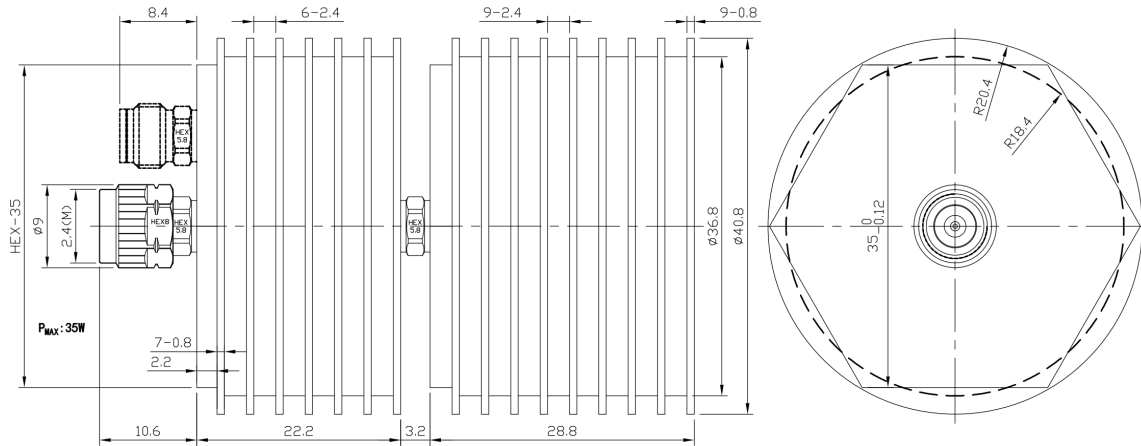

### Electrical & Environmental

<b>Frequency Range</b>	DC-50GHz	<b>Impedance</b>	50 ohm	<b>VSWR</b>	1.38 max
<b>Input Avg Power</b>	35W @25°C	<b>Peak Power</b>	100W (5μsec pulse width, 10% duty cycle)		

### Mechanical & Product Information

<b>Product Number</b>	RT5035F, JP-Grade	<b>Connector</b>	2.4mm Female
<b>Connector Body</b>	Passivated stainless steel	<b>Heat Sink</b>	Black anodized aluminum
<b>Center Contact</b>	1.27um gold plated beryllium copper		
<b>Operating Temp</b>	-55°C~+100°C	<b>Net Weight</b>	About 155.0g

### Typical Test Data

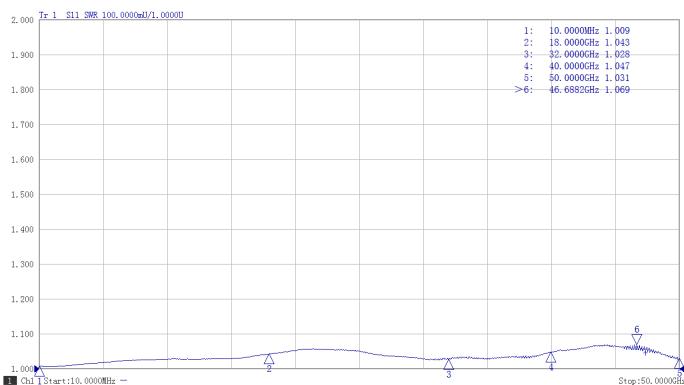

1. Customized connectors, dimensions, PIM, VSWR.
2. Refer to the RFTOP Termination selection and usage guide.

**Notes:** To ensure longevity and performance, do not use at full power for a long time. Peak power, pulse width, and duty cycle need to meet the requirements. Input high power, require heat dissipation, maintain temperature within 60°C. Reference Curve, derate linearly to 4W at 100°C.

