

2.4mm Male Coaxial Termination, RT5015M DC-50GHz, 15W, Round

Dimensions(mm) Tolerance±1%

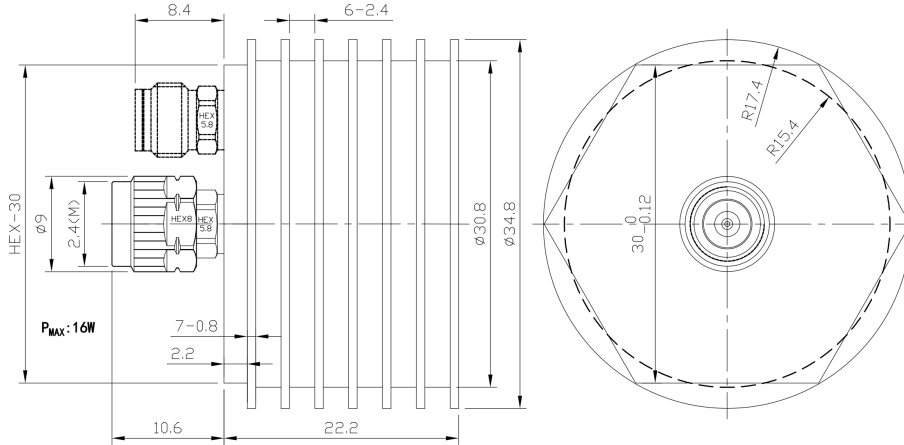

Electrical & Environmental

Frequency Range	DC-50GHz	Impedance	50 ohm	VSWR	1.3 max
Input Avg Power	15W @25°C	Peak Power	100W (5μsec pulse width, 6% duty cycle)		

Mechanical & Product Information

Product Number	RT5015M, JP-Grade	Connector	2.4mm Male
Connector Body	Passivated stainless steel	Heat Sink	Black anodized aluminum
Center Contact	1.27um gold plated beryllium copper		
Operating Temp	-55°C~+100°C	Net Weight	About 50.0g

Typical Test Data

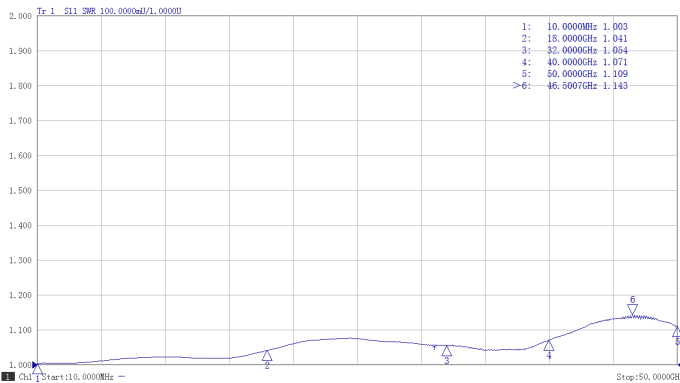

1. Customized connectors, dimensions, PIM, VSWR.
2. Refer to the RFTOP Termination selection and usage guide.

Notes: To ensure longevity and performance, do not use at full power for a long time. Peak power, pulse width, and duty cycle need to meet the requirements. Input high power, require heat dissipation, maintain temperature within 60°C. Reference Curve, derate linearly to 2W at 100°C.

