

N Male Coaxial Termination, RT18600NM DC-18GHz, 600W, Rectangular

Dimensions(mm) Tolerance $\pm 1\%$

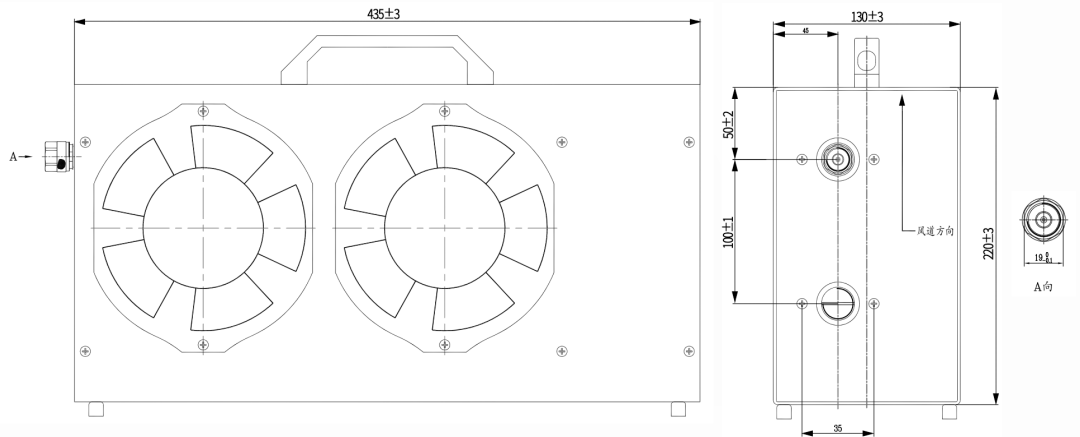

Electrical & Environmental

Frequency Range	DC-18GHz	Impedance	50 ohm	VSWR	1.45 max
Input Avg Power	600W @25°C	Peak Power	1kW (5 μ sec pulse width, 1% duty cycle)		

Mechanical & Product Information

Product Number	RT18600NM, P-Grade	Connector	N Male
Connector Body	Ternary alloy plated brass	Heat Sink	Black anodized aluminum
Center Contact	Gold plated brass		
Operating Temp	-55°C~+125°C	Net Weight	-

Typical Test Data

Notes

1. Customized outlines and optimal VSWR available.
2. Refer to the derating curve for power input, derate linearly to 60W at 100°C.
3. To maintain best performance, recommended to use fan to keep the case temp under 85°C.

