

## TNC Female Coaxial Termination, RT1250TF DC-12.4GHz, 50W, Round

### Dimensions(mm) Tolerance±1%

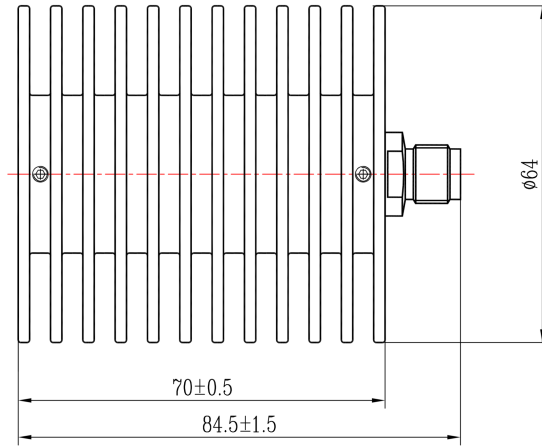

### Electrical & Environmental

<b>Frequency Range</b>	DC-12.4GHz	<b>Impedance</b>	50 ohm	<b>VSWR</b>	1.3 max
<b>Input Avg Power</b>	50W @25°C	<b>Peak Power</b>	500W (5μsec pulse width, 5% duty cycle)		

### Mechanical & Product Information

<b>Product Number</b>	RT1250TF, P-Grade	<b>Connector</b>	TNC Female
<b>Connector Body</b>	Ternary alloy plated brass	<b>Heat Sink</b>	Black anodized aluminum
<b>Center Contact</b>	Gold plated beryllium copper		
<b>Operating Temp</b>	-55°C~+125°C	<b>Net Weight</b>	-

1. Customized connectors, dimensions, PIM, VSWR.
2. Refer to the RFTOP Termination selection and usage guide.

**Notes:** To ensure longevity and performance, do not use at full power for a long time. Peak power, pulse width, and duty cycle need to meet the requirements. Input high power, require heat dissipation, maintain temperature within 60°C. Reference Curve, derate linearly to 5W at 100°C.

