

WR6(BJ1400) Short-circuiter, **RWGSC6**
114-173GHz, FUGP1400 Circular Flange

Dimensions(mm) Tolerance $\pm 1\%$

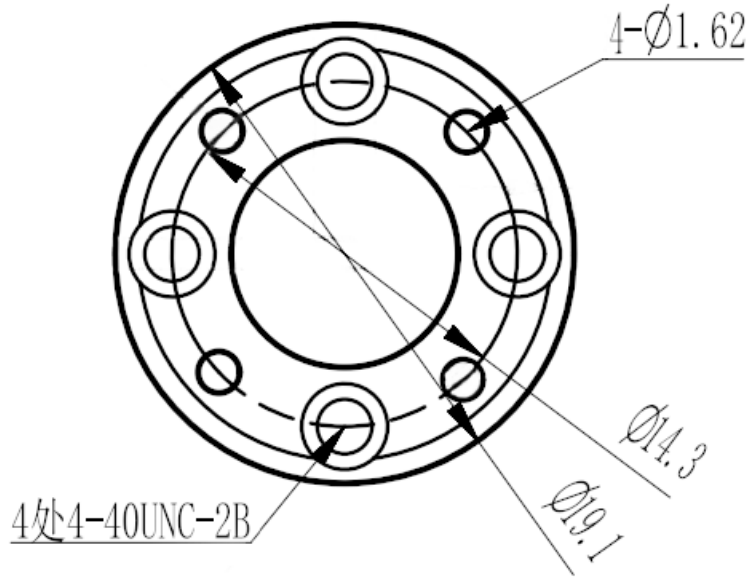

Electrical & Environmental

Frequency Range	114-173GHz
Temperature Range	-40°C to 70°C

Mechanical & Product Information

Product Number	RWGSC6
Product Type	Short-circuiter
Waveguide 1	WR6(BJ1400), FUGP1400 Circular Flange
Waveguide 2	WR6(BJ1400), FUGP1400 Circular Flange
Waveguide Body	Copper, gold plated
Center Contact	Copper, gold plated