

WR5(BJ1800) Short-circuiter, **RWGSC5**  
145-220GHz, FUGP1800 Circular Flange

Dimensions(mm) Tolerance $\pm 1\%$

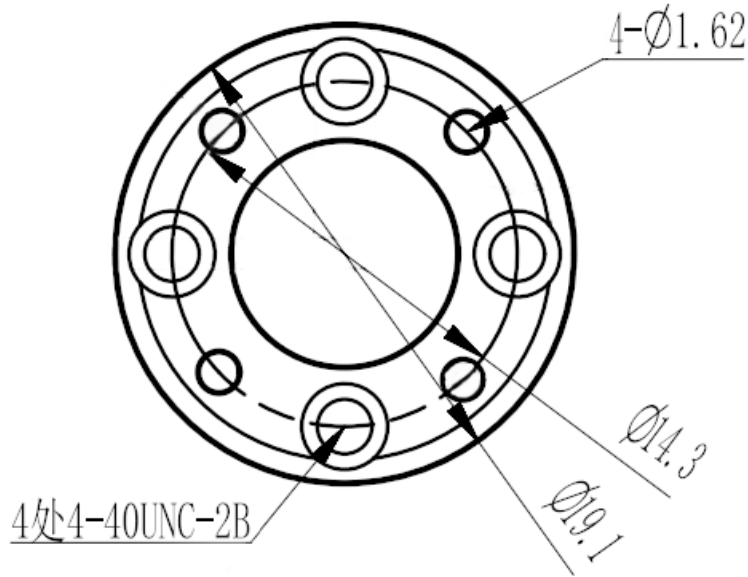

Electrical & Environmental

Frequency Range	145-220GHz
Temperature Range	-40°C to 70°C

Mechanical & Product Information

Product Number	RWGSC5
Product Type	Short-circuiter
Waveguide 1	WR5(BJ1800), FUGP1800 Circular Flange
Waveguide 2	WR5(BJ1800), FUGP1800 Circular Flange
Waveguide Body	Copper, gold plated
Center Contact	Copper, gold plated