

WR10(BJ900) Short-circuiter, **RWGSC10**
73.8-112GHz, FUGP900 Circular Flange

Dimensions(mm) Tolerance $\pm 1\%$

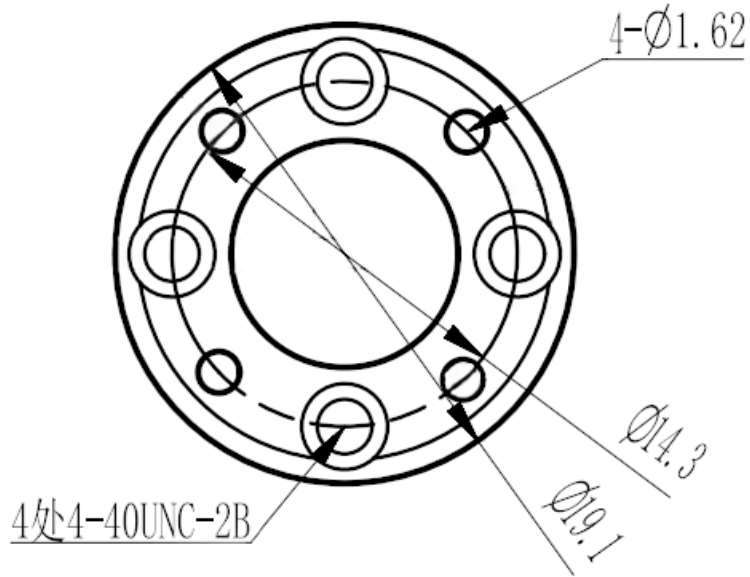

Electrical & Environmental

Frequency Range	73.8-112GHz
Temperature Range	-40°C to 70°C

Mechanical & Product Information

Product Number	RWGSC10
Product Type	Short-circuiter
Waveguide 1	WR10(BJ900), FUGP900 Circular Flange
Waveguide 2	WR10(BJ900), FUGP900 Circular Flange
Waveguide Body	Copper, gold plated
Center Contact	Copper, gold plated