

WR4(R2200) 1/4 Line, RWGQL4
172-261GHz, FUGP2200 Flange

Dimensions(mm) Tolerance $\pm 1\%$

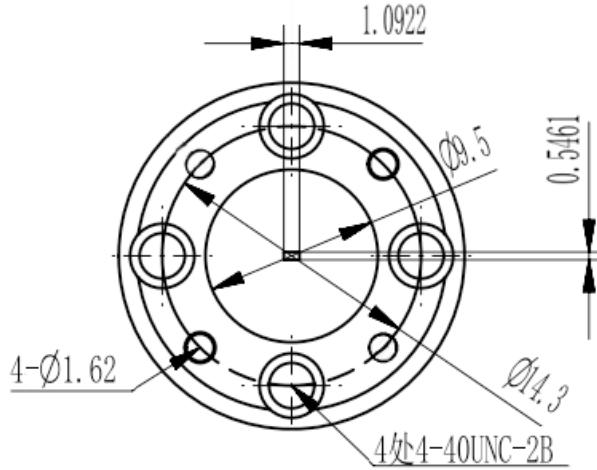

Electrical & Environmental

Frequency Range	172-261GHz
Temperature Range	-40°C~+70°C

Mechanical & Product Information

Product Number	RWGQL4
Product Type	1/4 Line
Waveguide 1	WR4(R2200), FUGP2200 Flange
Waveguide 2	WR4(R2200), FUGP2200 Flange
Waveguide Body	Copper, gold plated
Center Contact	Copper, gold plated