

SMA一分二电阻式功分器, RPD18S2-C
DC-18GHz, 1W, 专业型, 接头不锈钢

结构尺寸图 (单位: mm) 误差±1%

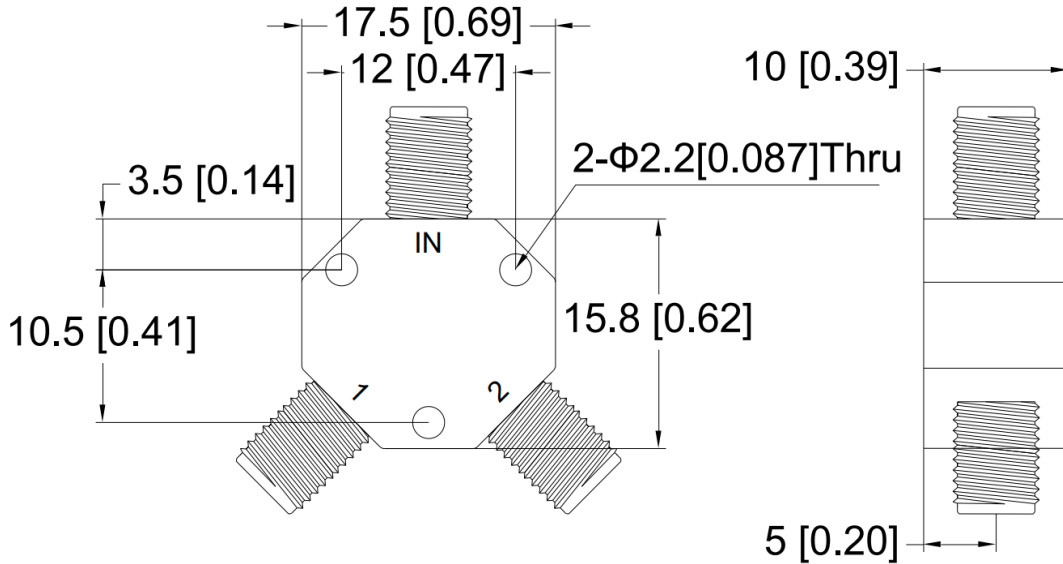

电气与环境性能

频率范围	DC-18GHz	阻抗	50 Ohm
输入驻波	1.3 max		
输出驻波	2 max		
插入损耗	1.5dB max (does not include the theoretical insertion loss -6dB)		
隔离度	10dB min		
幅度平衡	± 0.4dB		
相位平衡	±4°		
承受功率	1W @25°C		
温度范围	-45°C ~ +85°C		

产品和材料信息

产品型号	RPD18S2-C, 专业型	功分路数	一分二
连接器类型	SMA母头	连接器主体	Passivated stainless steel
内腔/内导体	Gold plated beryllium copper		
产品壳体	Blue paint		
外形尺寸	17.5×15.8×10mm	产品净重	约 25.0g



微信扫描
关注我们

RFTOP®频优微波
高品质微波毫米波器件供应商

www.rftop.cn
service@rftop.com 0755-88840350

微信扫描
在线咨询



SMA一分二电阻式功分器, RPD18S2-C
DC-18GHz, 1W, 专业型, 接头不锈钢

典型实测曲线

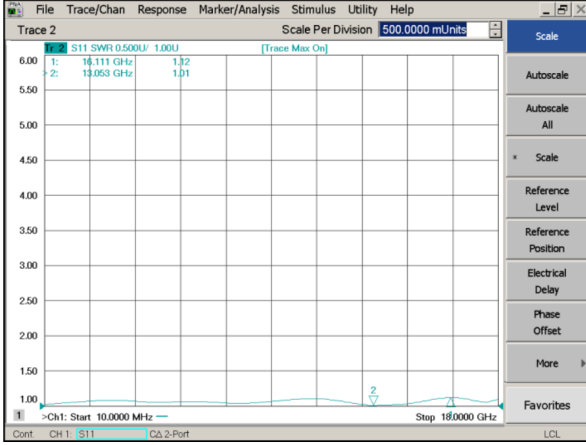

Input Port VSWR

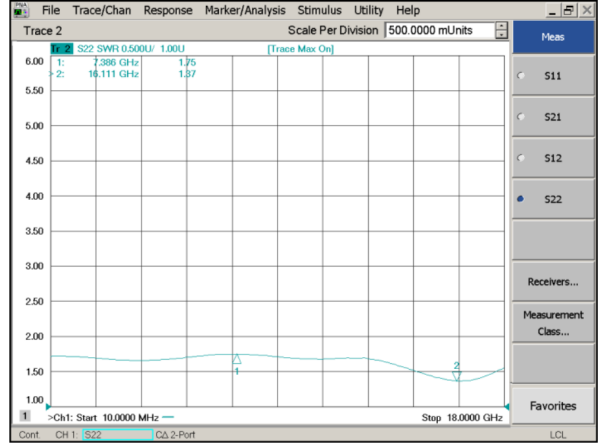

Output Port VSWR

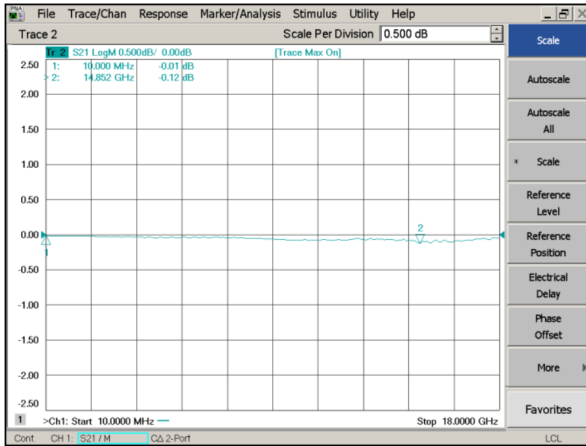

Amplitude Balance

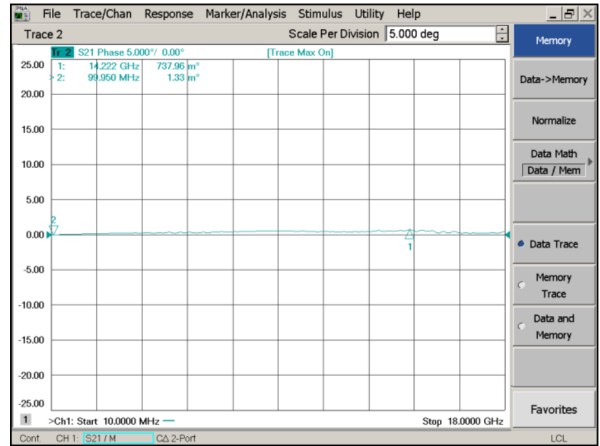

Phase Balance

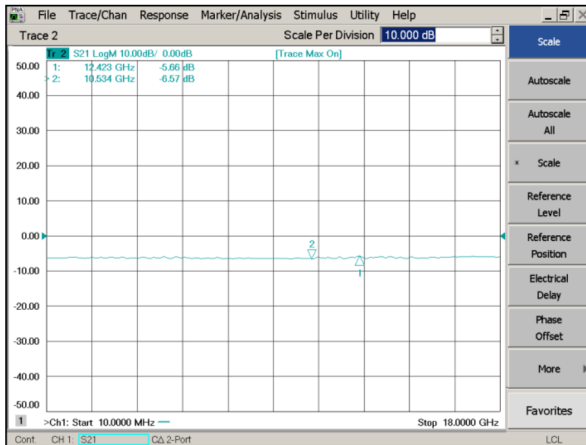

Insertion Loss

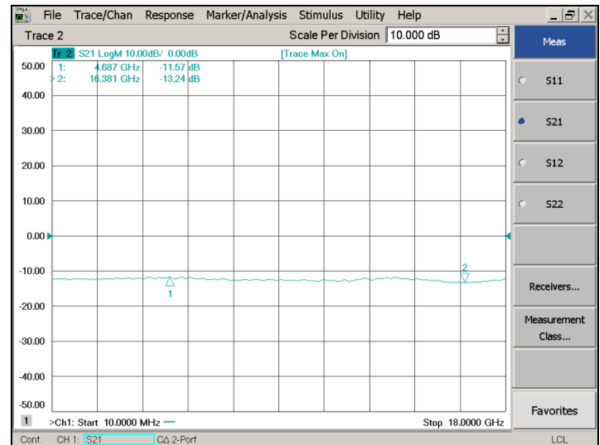

Isolation



微信扫描
关注我们

RFTOP®频优微波
高品质微波毫米波器件供应商

www.rftop.cn
service@rftop.com 0755-88840350

微信扫描
在线咨询

