

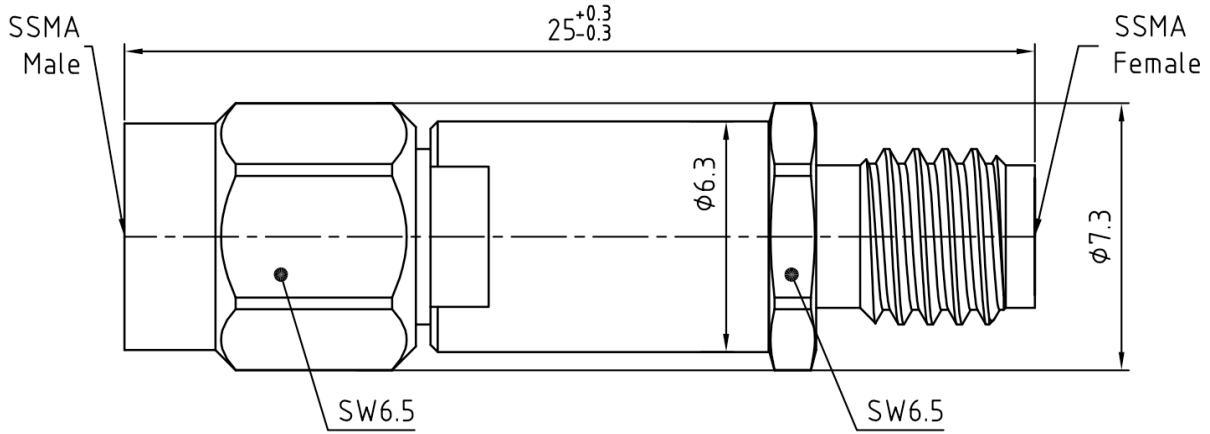

SSMA Male to SSMA Female Inner DC Block, RBK40SA50 9KHz-40GHz, 50V

Dimensions(mm) Tolerance±1%



Electrical & Environmental

Frequency Range	9KHz-40GHz	Impedance	50 Ohm
VSWR	1.6 Max	Insertion Loss	1.2 dB Max
Voltage	50 Volts Max	Input Avg Power	-

Mechanical & Product Information

Product Number	RBK40SA50	Connector	SSMA Male to SSMA Female
Connector Body	Passivated stainless steel, Gold plated brass, Gold plated beryllium copper	Center Contact	Gold plated brass, Gold plated beryllium copper
Net Weight	-	RoHS	Compliant

Typical Test Data

