

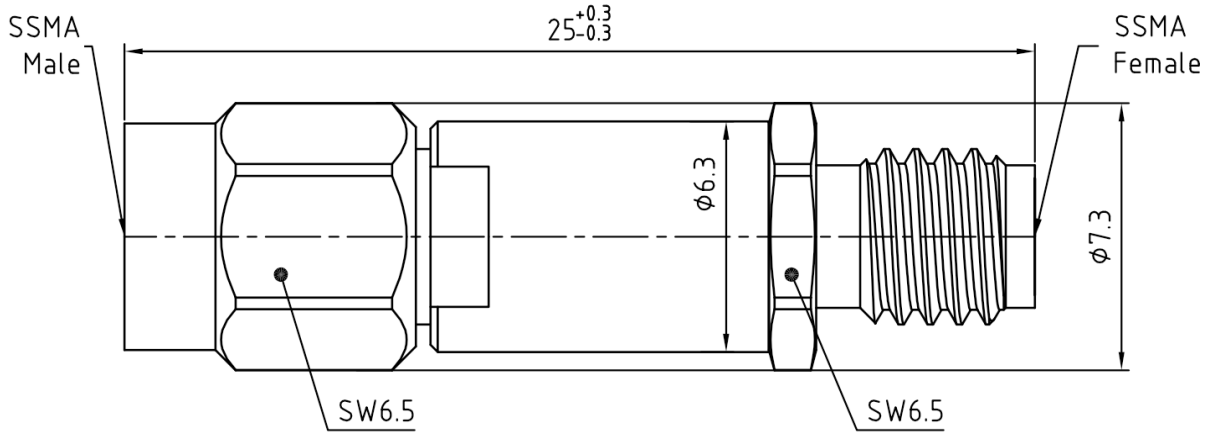

SSMA公头转SSMA母头内隔直器, RBK27SA50
9KHz-26.5GHz, 50V, 不锈钢+黄铜镀金+铍铜镀金

结构尺寸图 (单位: mm) 误差±1%



电气与环境性能

频率范围	9KHz-26.5GHz	阻抗	50 Ohm
电压驻波比	1.4 Max	插损	0.8 dB max
额定电压	50 Volts Max	平均功率	-

产品和材料信息

产品型号	RBK27SA50	接头类型	SSMA公头转SSMA母头
接头材质	Passivated stainless steel, Gold plated brass, Gold plated beryllium copper	内导体	Gold plated brass, Gold plated beryllium copper
净重	-	RoHS	Compliant

典型测试数据

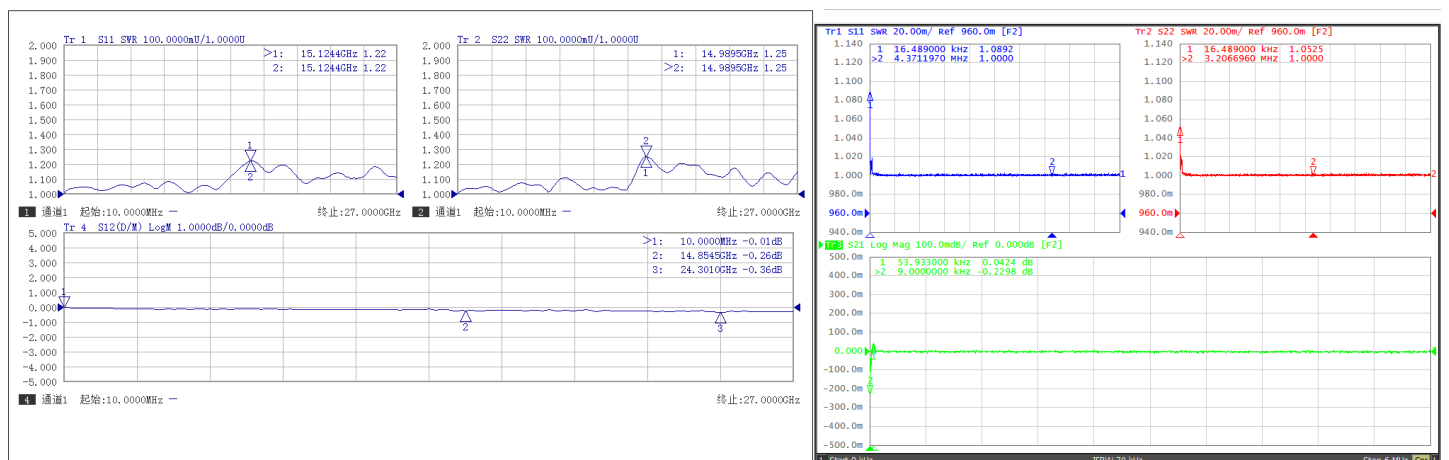

微信扫描
关注我们

RFTOP®频优微波
 高品质微波毫米波器件供应商

www.rftop.cn
 service@rftop.com 0755-88840350

微信扫描
在线咨询

