

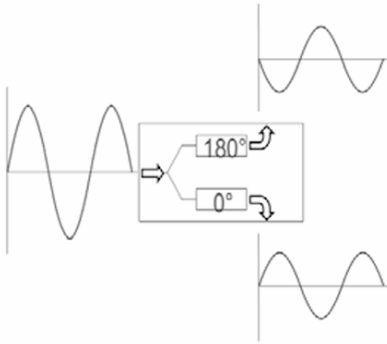

1.0mm Balun, RBLM10F90 10MHz-90GHz, 1W

Dimensions(mm) Tolerance $\pm 1\%$



单端-差分信号变换

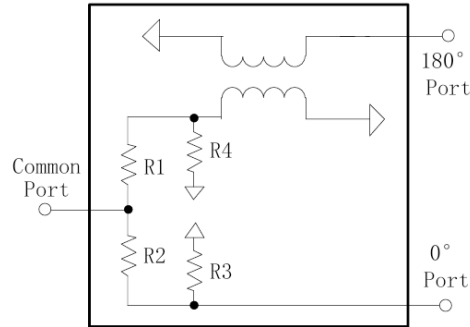

宽带巴伦原理框图

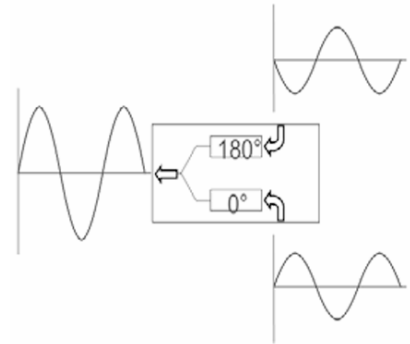

差分-单端信号变换

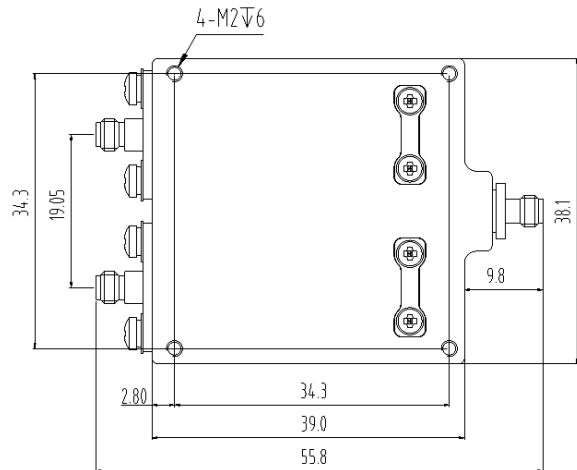
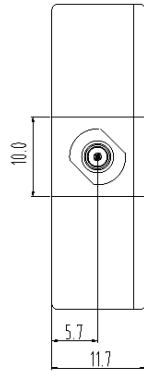
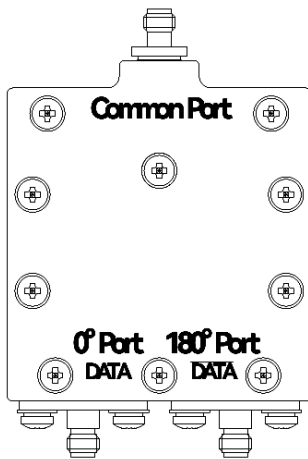

Electrical & Environmental

Frequency Range	10MHz-90GHz	Impedance	50 Ohm
VSWR Primary	1.5 Max (Typ.1.4)		
VSWR Secondary	2.1 Max (Typ.1.7)		
Insertion Loss	10.8dB Max (Typ.9.2dB)		
Phase Balance	$\pm 6^\circ$ (Typ. $\pm 4^\circ$)		
Input Avg Power	1 Watts max @25°C		
Operating Temp	-40°C~+70°C		

Mechanical & Product Information

Product Number	RBLM10F90	Product Type	Balun
Connector	1.0mm Female	Connector Body	Passivated stainless steel
Center Contact	Gold plated beryllium copper		
Housing	Grey paint		
Dimensions	39(L) \times 38.1(W) \times 11.7(H)mm	Net Weight	About 50.0g



Microwave and Millimeter wave products
supplier

RFTOP® Technology Co., Ltd.
www.rftop.com service@rftop.com 86-755-88840350