

2.4mm Female Cable Connector, RC50UF-BT220KJ DC-50GHz, Straight, Attachment for CNC220-KJ Cable

Dimensions(mm) Tolerance±1%

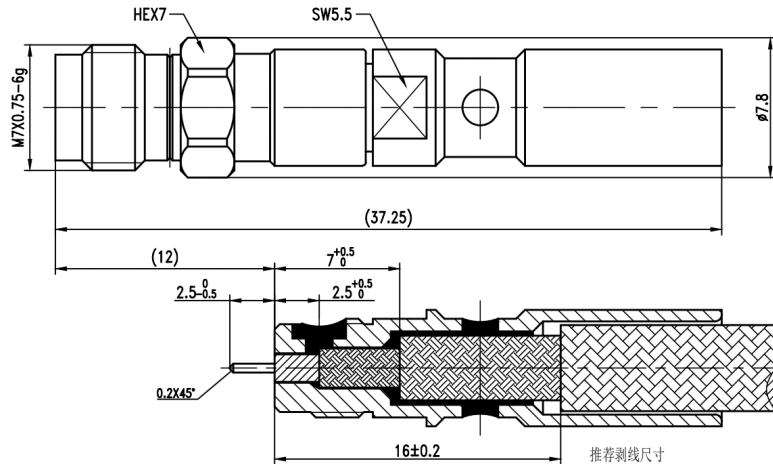

Electrical & Environmental

Frequency Range	DC-50GHz	Impedance	50 ohm
VSWR	1.35 Max	Withstand Voltage	500 V
Mating Cycles	> 500 Cycles	Temperature Range	-55°C ~ +165°C

Mechanical & Product Information

Product Number	RC50UF-BT220KJ, P-Grade	Connector	2.4mm Female
Shape/Mounting	Straight	Attachment Method	Solder
Attachment for	CNC220-KJ Series Cable		
Connector Body	Passivated stainless steel 316F/Gold plated brass	Insulator	PEI
Center Contact	Gold plated beryllium copper		
Dimension	37.25(L)mm	Net Weight	-