

2.4mm Female Field Replaceable Connector, RC50F-UFD03-3 DC-50GHz, Straight, 2 hole flange, 8.6mm Hole Spacing, 0.3mm Pin

Dimensions(mm) Tolerance $\pm 1\%$

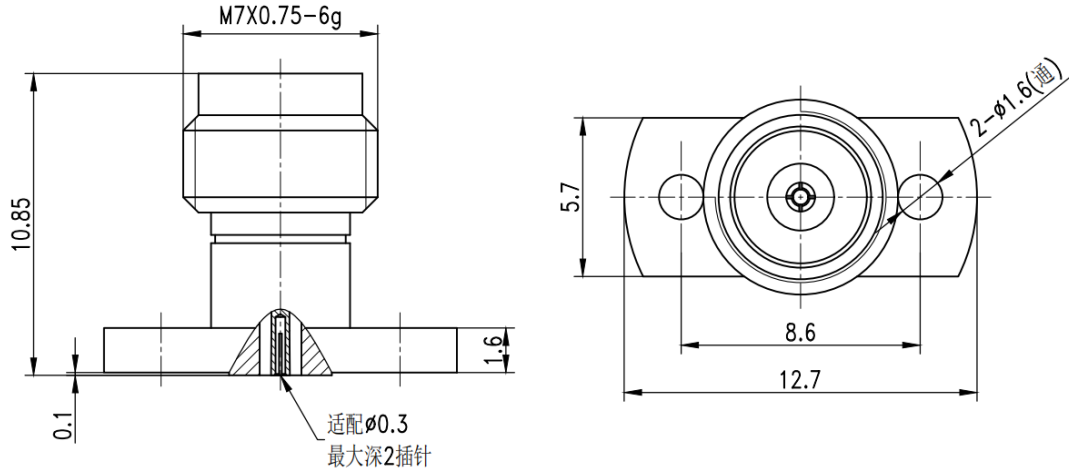

Electrical & Environmental

Frequency Range	DC-50GHz
Impedance	50 ohm
Contact Resistance	\leq In:3.0/Out:2.0 m Ω
Insulation Resistance	\geq 5000 M Ω
Withstand Voltage	500 V
Mating Cycles	> 500 Cycles
Temperature Range	-55 $^{\circ}$ C~+165 $^{\circ}$ C

Mechanical & Product Information

Product Number	RC50F-UFD03-3, H-Grade
Product Type	2.4mm Female, Field Replaceable Connector
Shape/Mounting	Straight, 2 hole flange
Attachment Method	Field Replaceable
Connector Body	Passivated stainless steel 316F
Center Contact	Gold plated beryllium copper
Insulator	PEI
Dimension	10.85(L)mm