

SMA Female Bulkhead Flange Connector, RC27SF-MD127 DC-26.5GHz, Straight, 1.27mm Pin

Dimensions(mm) Tolerance $\pm 1\%$

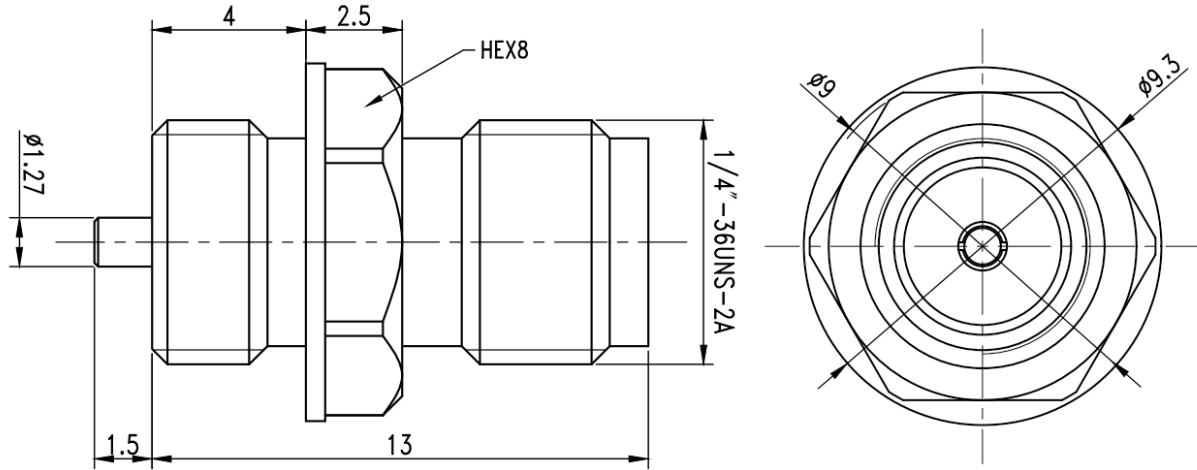

Electrical & Environmental

Frequency Range	DC-26.5GHz
Impedance	50 ohm
Contact Resistance	\leq In:3.0/Out:2.0 m Ω
Insulation Resistance	\geq 5000 M Ω
Withstand Voltage	1000 V
Mating Cycles	> 500 Cycles
Temperature Range	-55 $^{\circ}$ C~+165 $^{\circ}$ C

Mechanical & Product Information

Product Number	RC27SF-MD127, H-Grade
Product Type	SMA Female, Bulkhead Flange Connector
Shape/Mounting	Straight
Attachment Method	Solder
Center Contact	Gold plated beryllium copper
Dimension	14.5(L)mm