

1.0mm Male Field Replaceable Connector, RC110WM-UF2D12-XX DC-110GHz, Straight, 2 hole flange, 7.1mm Hole Spacing

Dimensions(mm) Tolerance±1%

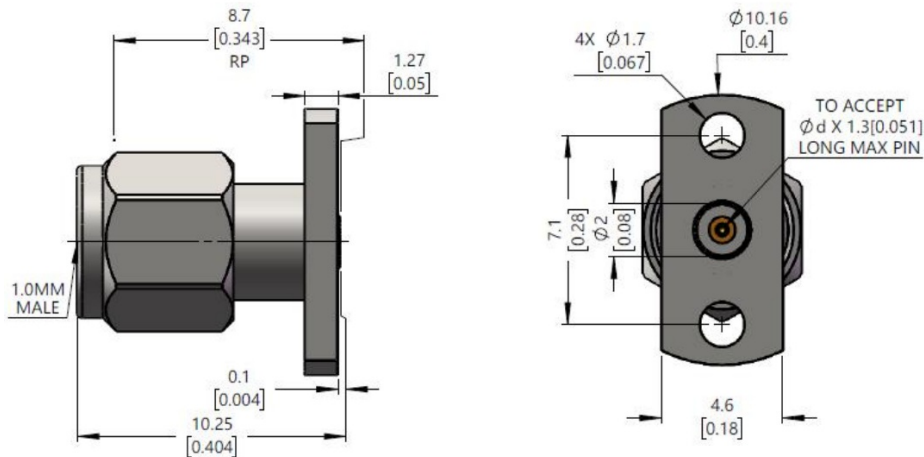

Product Selection

D(mm)	RFTOP P/N
0.23	RC110WM-UF2D12-023

Electrical & Environmental

Frequency Range	DC-110GHz	Impedance	50 ohm
VSWR	1.5 max	Withstand Voltage	750 V
Insulation Resistance	≥ 5000 MΩ	Contact Resistance	≤ In:3.0/Out:2.0 mΩ
Mating Cycles	> 500 Cycles	Temperature Range	-55°C~+165°C

Mechanical & Product Information

Product Number	RC110WM-UF2D12-XX	Connector	1.0mm Male
Shape/Mounting	Straight , 2 hole flange	Attachment Method	Field Replaceable
Connector Body	Passivated stainless steel	Insulator	PEI
Center Contact	Gold plated beryllium copper		
Dimension	10.25(L)mm	Net Weight	-