

TNC Coaxial Fixed Attenuator, R6T100UAB-XX DC-6GHz, 100W, 6-60dB, Unidirectional, Rectangular

Dimensions(mm) Tolerance±1%

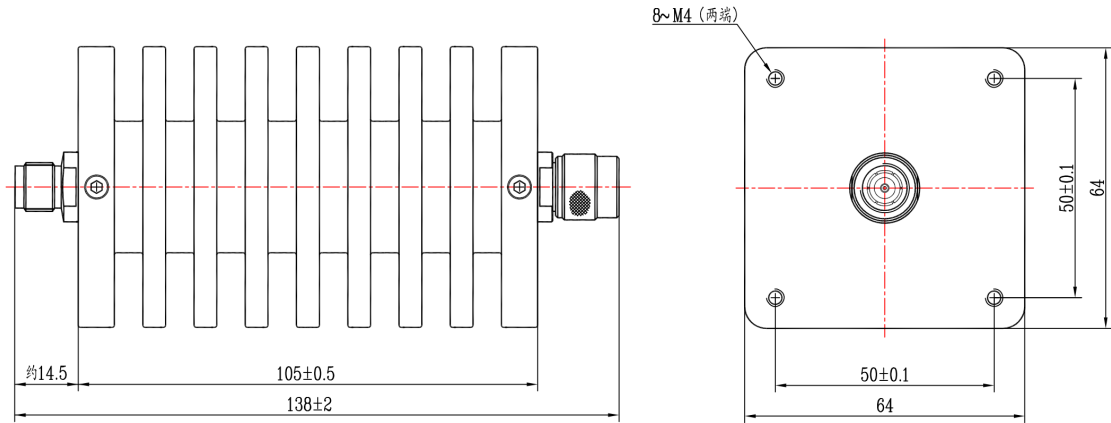

Electrical & Environmental

Frequency Range	DC-6GHz , 50Ohms
VSWR	1.25 Max
Input Avg Power	100W @25°C
Peak Power	1kW (5μsec pulse width, 5% duty cycle)
Temp Coefficient	<0.0004 dB/dB/°C
Direction	Unidirectional, TNC male input to TNC female output
Attenuation	6-60dB
Operating Temp	-55°C~+125°C

Product Selection, Customizable		
RFTOP P/N	ATTEN	Accuracy
R6T100UAB-6	6 dB	±0.8 dB
R6T100UAB-10	10 dB	±0.8 dB
R6T100UAB-20	20 dB	±0.8 dB
R6T100UAB-30	30 dB	±0.9 dB
R6T100UAB-40	40 dB	±0.9 dB
R6T100UAB-50	50 dB	±1.0 dB
R6T100UAB-60	60 dB	±1.0 dB

Mechanical & Product Information

Product Number	R6T100UAB-XX
Product Type	Coaxial Fixed Attenuator, P-Grade
Connector	TNC male, TNC female
Connector Body	Ternary alloy plated brass
Center Contact	Gold plated brass, Gold plated beryllium copper
Heat Sink	Black anodized aluminum

1. Customized connectors, dimensions, directionality, PIM, dB values.
2. Refer to the RFTOP attenuator selection and usage guide.

Notes: Pay attention to input/output. To ensure longevity and performance, do not use at full power for a long time. Peak power, pulse width, and duty cycle need to meet the requirements. Input high power, require heat dissipation, maintain temperature within 80°C. Reference Curve, derate linearly to 10W at 100°C.

