

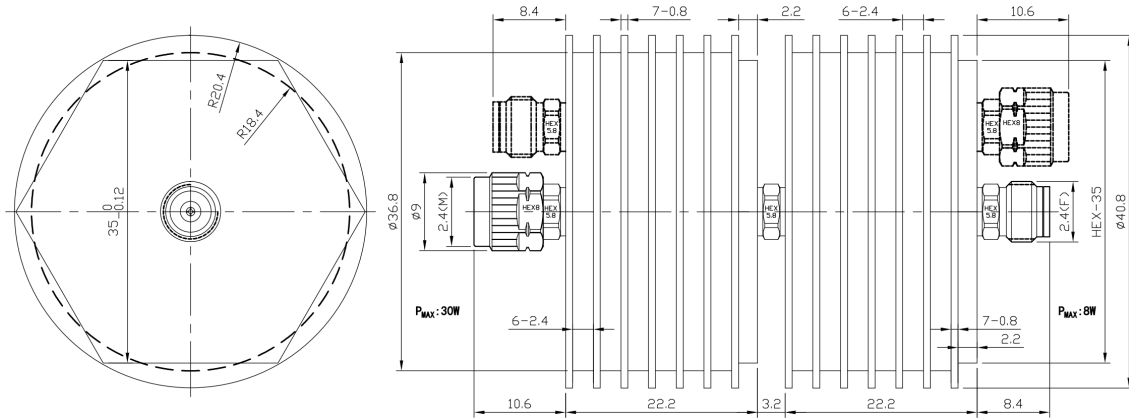

2.4mm Coaxial Fixed Attenuator, R5030U-XX DC-50GHz, 30W, 10-40dB, Unidirectional, Round

Dimensions(mm) Tolerance±1%



Electrical & Environmental

Frequency Range	DC-50GHz , 50Ohms
VSWR	1.38 Max
Input Avg Power	30W @25°C
Peak Power	100W (5μsec pulse width, 10% duty cycle)
Temp Coefficient	<0.0004 dB/dB/°C
Direction	Unidirectional, 2.4mm male input to 2.4mm female output
Attenuation	10-40dB
Operating Temp	-55°C~+100°C

Product Selection, Customizable

RFTOP P/N	ATTEN	Accuracy
R5030U-10	10 dB	+2.5/-2.2 dB
R5030U-20	20 dB	+2.0/-1.8 dB
R5030U-30	30 dB	+2.0/-1.8 dB
R5030U-40	40 dB	+2.0/-1.8 dB

Notes: Pay attention to input/output. To ensure longevity and performance, do not use at full power for a long time. Peak power, pulse width, and duty cycle need to meet the requirements. Input high power, require heat dissipation, maintain temperature within 80°C. Reference Curve, derate linearly to 3W at 100°C.

Mechanical & Product Information

Product Number	R5030U-XX
Product Type	Coaxial Fixed Attenuator, JP-Grade
Connector	2.4mm male, 2.4mm female
Connector Body	Passivated stainless steel
Center Contact	1.27um Gold plated beryllium copper
Heat Sink	Black anodized aluminum
Net Weight	About 130.0g

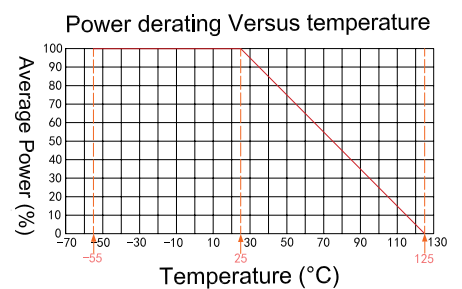

1. Customized connectors, dimensions, directionality, PIM, dB values.
2. Refer to the RFTOP attenuator selection and usage guide.