

N Coaxial Fixed Attenuator, R4N5MM-XX DC-4GHz, 5W, 1-40dB, Bidirectional, Round

Dimensions(mm) Tolerance±1%

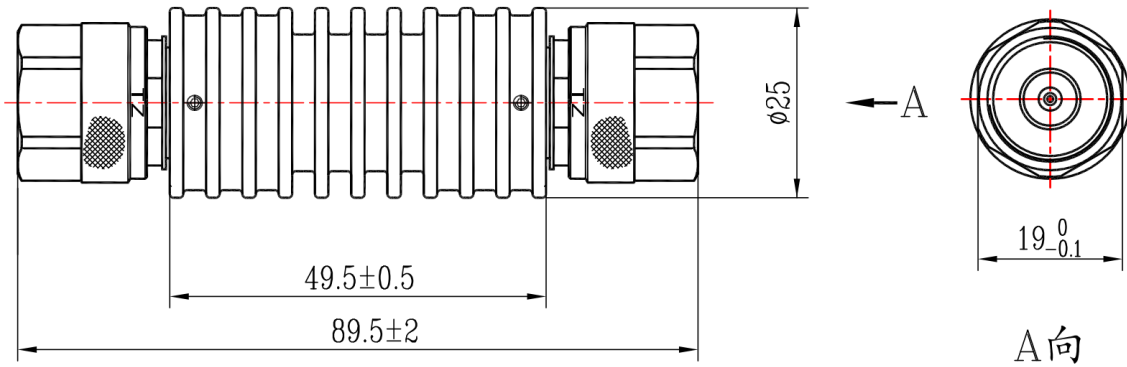

Typical Value	
RFTOP P/N	
R4N5MM-3	
R4N5MM-6	
R4N5MM-10	
R4N5MM-20	
R4N5MM-30	
R4N5MM-40	

Electrical & Environmental

Frequency Range	DC-4GHz	Impedance	50 ohm	VSWR	1.2 max
Input Avg Power	5W @25°C	Peak Power	500W (5μsec pulse width, 0.5% duty cycle)		
Temp Coefficient	<0.0004 dB/dB/°C	Attenuation	1-40dB, Customizable		
Direction	Bidirectional, N male to N male				

Mechanical & Product Information

Product Number	R4N5MM-XX, Professional	Connector	N
Connector Body	Ternary alloy plated brass	Heat Sink	Black anodized aluminum
Center Contact	Gold plated brass, Gold plated beryllium copper		
Operating Temp	-55°C~+125°C	Net Weight	-

Attenuation&Accuracy(DC-4GHz)

Attenuation(dB)	1-10	20	30	40	50	60
Accuracy(dB)	±0.4	±0.5	±0.6	±0.7	±0.7	±0.8

Notes

1. Refer to the derating curve for power input, derate linearly to 0.5 W at 100°C.
2. Customized dB values, outlines and optimal accuracy & VSWR available.

