

N Coaxial Fixed Attenuator, R4N50AB-XX DC-4GHz, 50W, 1-60dB, Bidirectional, Rectangular

Dimensions(mm) Tolerance $\pm 1\%$

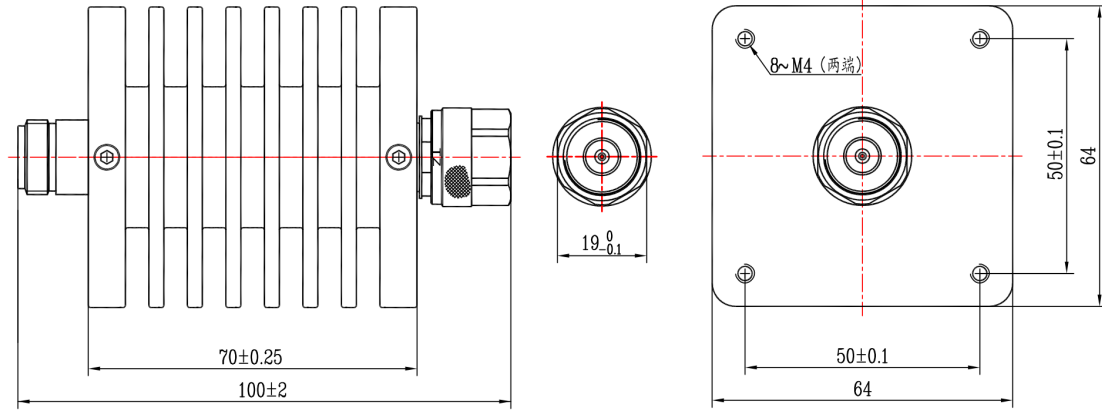

Electrical & Environmental

Frequency Range	DC-4GHz , 50Ohms
VSWR	1.2 Max
Input Avg Power	50W @25°C
Peak Power	500W (5μsec pulse width, 5% duty cycle)
Temp Coefficient	<0.0004 dB/dB/°C
Direction	Bidirectional, N male to N female
Attenuation	1-60dB
Operating Temp	-55°C~+125°C

Product Selection, Customizable

RFTOP P/N	ATTEN	Accuracy
R4N50AB-3	3 dB	± 0.4 dB
R4N50AB-6	6 dB	± 0.4 dB
R4N50AB-10	10 dB	± 0.4 dB
R4N50AB-20	20 dB	± 0.5 dB
R4N50AB-30	30 dB	± 0.7 dB
R4N50AB-40	40 dB	± 0.7 dB
R4N50AB-50	50 dB	± 0.7 dB
R4N50AB-60	60 dB	± 0.8 dB

Mechanical & Product Information

Product Number	R4N50AB-XX
Product Type	Coaxial Fixed Attenuator, P-Grade
Connector	N male, N female
Connector Body	Ternary alloy plated brass
Center Contact	Gold plated brass, Gold plated beryllium copper
Heat Sink	Black anodized aluminum

Notes: Pay attention to input/output. To ensure longevity and performance, do not use at full power for a long time. Peak power, pulse width, and duty cycle need to meet the requirements. Input high power, require heat dissipation, maintain temperature within 80°C. Reference Curve, derate linearly to 5W at 100°C.

1. Customized connectors, dimensions, directionality, PIM, dB values.
2. Refer to the RFTOP attenuator selection and usage guide.

