

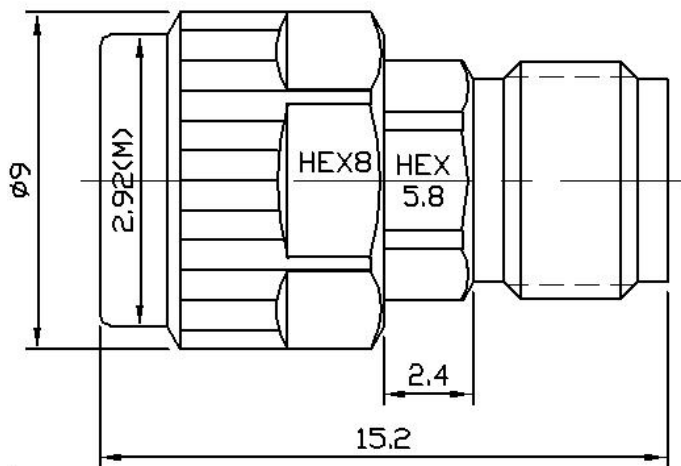

## 2.92mm毫米波同轴固定衰减器, R402-XX DC-40GHz, 2W, 1-40dB, 双向, 公头-母头, 圆形

结构尺寸图 (单位: mm) 误差±1%



典型衰减值
RFTOP P/N
R402-3
R402-4
R402-5
R402-6
R402-10
R402-20
R402-30
R402-40

### 电气与机械性能

频率范围	DC-40GHz	阻抗	50ohm	电压驻波比	1.2 max
平均功率	2W @25°C	峰值功率	200W (5µsec pulse width, 1% duty cycle)		
温度系数	<0.0004 dB/dB/°C	衰减值	1-40dB, 可定制		
功率方向性	Bidirectional, 2.92mm male to 2.92mm female				

### 产品和材料信息

产品型号	R402-XX, 普军级	同轴接头	2.92mm
接头主体	Passivated stainless steel	散热体	N/A
内导体	1.27µm Gold plated beryllium copper		
工作温度	-55°C~+125°C	净重	约 3.5g

### 衰减精度 (DC-40GHz)

Attenuation(dB)	1-3	4-8	9-15	16-30	31-33	34-36	37-39	40
Accuracy(dB)	-0.5/+0.8	-0.7/+0.9	-0.7/+0.7	-0.9/+1.0	-0.8/+0.8	-0.9/+0.9	-1.0/+1.0	-1.2/+1.2

### 使用说明及定制服务

- 请参考右侧功率降额曲线, 在100°C时线性降额至0.2W。
- 定制服务包括: 接头类型, 方向性, 特殊dB值, 外形尺寸, 更优的衰减精度及VSWR。

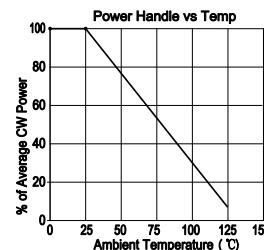

微信扫描  
关注我们

RFTOP®频优微波  
高品质微波毫米波器件供应商

www.rftop.cn  
service@rftop.com 0755-88840350

微信扫描  
在线咨询





## 2.92mm毫米波同轴固定衰减器, R402-XX DC-40GHz, 2W, 1-40dB, 双向, 公头-母头, 圆形

### 典型实测曲线

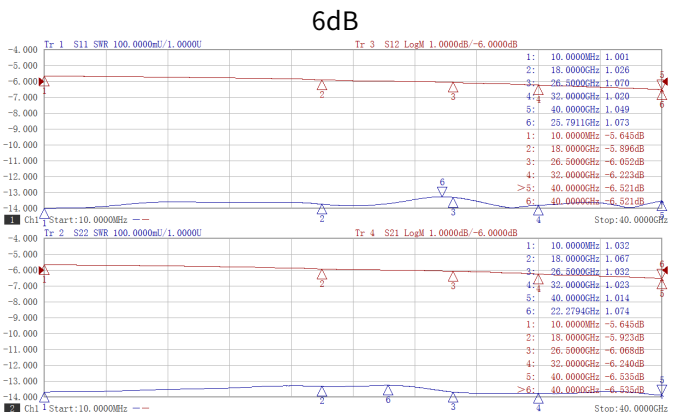
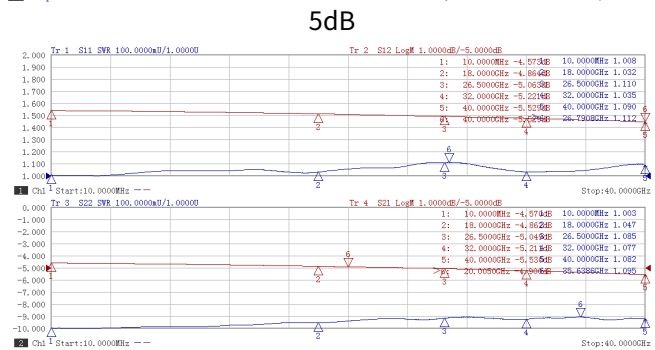
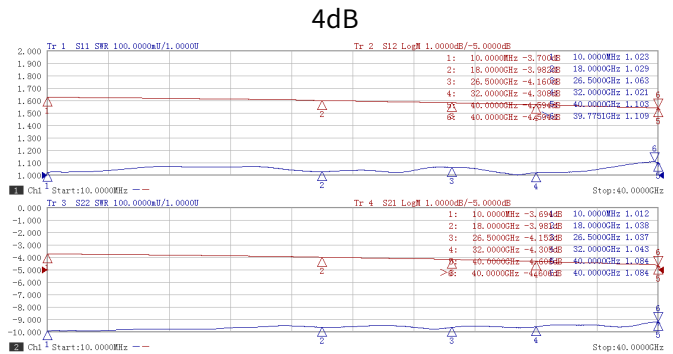
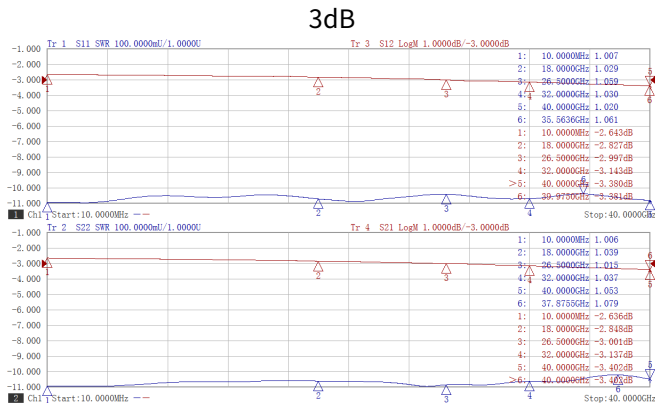
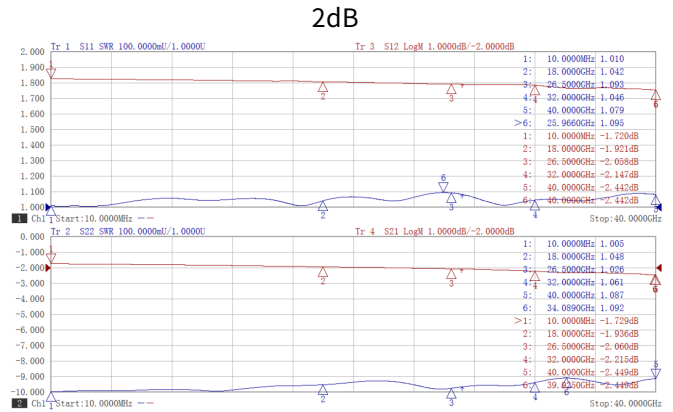
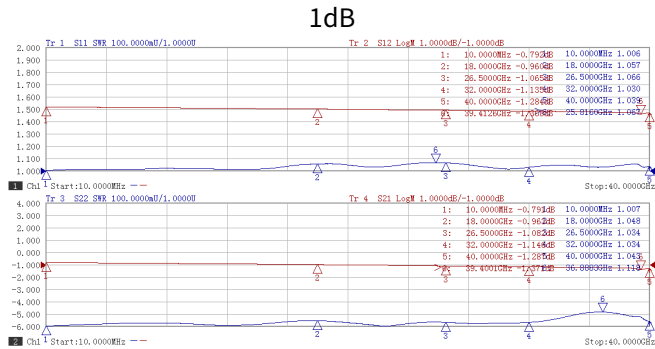

微信扫描  
关注我们

RFTOP®频优微波  
高品质微波毫米波器件供应商

www.rftop.cn  
service@rftop.com 0755-88840350

微信扫描  
在线咨询

