

4.3-10 Coaxial Fixed Attenuator, R3P100UAB-XX DC-3GHz, 100W, 6-60dB, Unidirectional, Rectangular

Dimensions(mm) Tolerance±1%

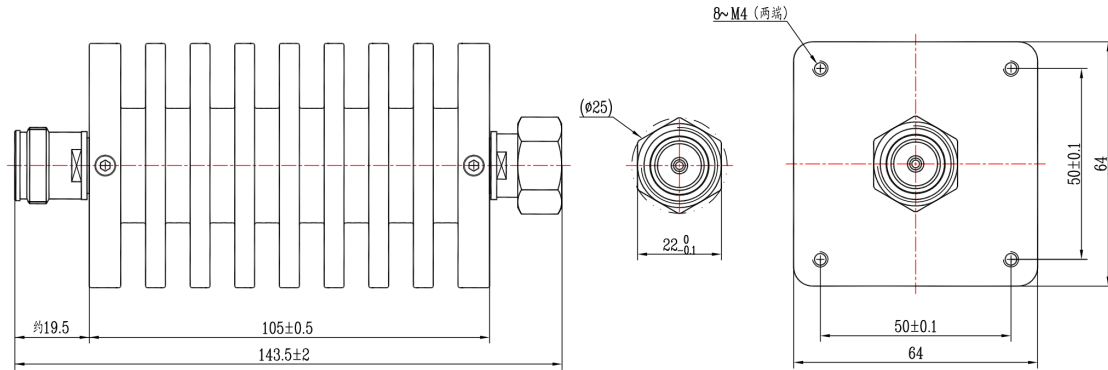

Electrical & Environmental

Frequency Range	DC-3GHz , 50Ohms
VSWR	1.2 Max
Input Avg Power	100W @25°C
Peak Power	1kW (5μsec pulse width, 5% duty cycle)
Temp Coefficient	<0.0004 dB/dB/°C
Direction	Unidirectional, 4.3-10 male input to 4.3-10 female output
Attenuation	6-60dB
Operating Temp	-55°C~+125°C

Product Selection, Customizable		
RFTOP P/N	ATTEN	Accuracy
R3P100UAB-6	6 dB	±0.7 dB
R3P100UAB-10	10 dB	±0.7 dB
R3P100UAB-20	20 dB	±0.7 dB
R3P100UAB-30	30 dB	±0.8 dB
R3P100UAB-40	40 dB	±0.8 dB
R3P100UAB-50	50 dB	±0.8 dB
R3P100UAB-60	60 dB	±1.0 dB

Mechanical & Product Information

Product Number	R3P100UAB-XX
Product Type	Coaxial Fixed Attenuator, P-Grade
Connector	4.3-10 male, 4.3-10 female
Connector Body	Ternary alloy plated brass
Center Contact	Gold plated brass, Gold plated beryllium copper
Heat Sink	Black anodized aluminum

Notes: Pay attention to input/output. To ensure longevity and performance, do not use at full power for a long time. Peak power, pulse width, and duty cycle need to meet the requirements. Input high power, require heat dissipation, maintain temperature within 80°C. Reference Curve, derate linearly to 10W at 100°C.

1. Customized connectors, dimensions, directionality, PIM, dB values.
2. Refer to the RFTOP attenuator selection and usage guide.

