

WR90 Standard Gain Horn Antenna, RWHA90-25
8.2-12.5GHz, 25dB Nominal Gain, FBP100(UBR) Flange

Dimensions(mm) Tolerance±1%

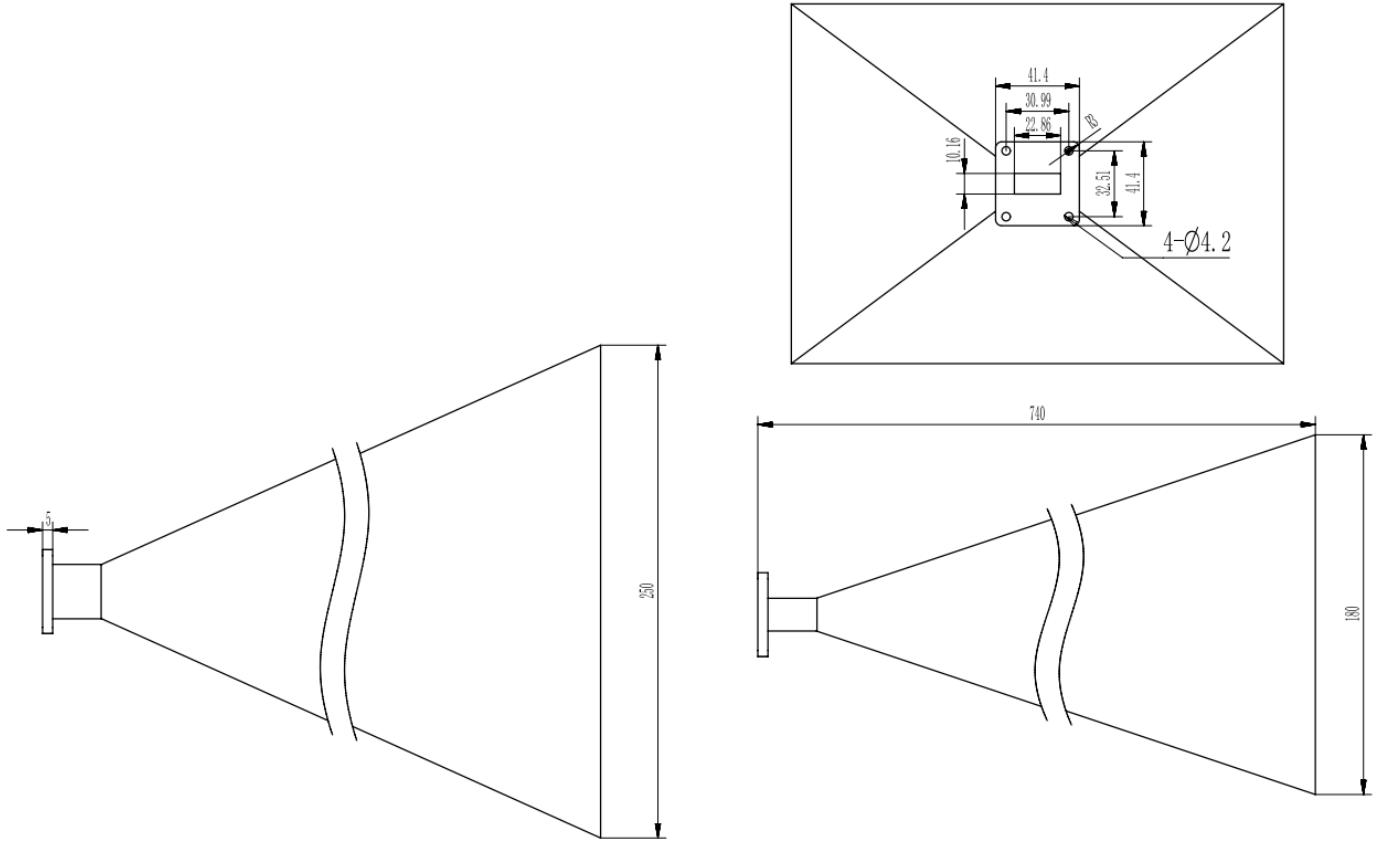

Electrical & Environmental

Frequency Range	8.2-12.5GHz	Impedance	50 Ohm
VSWR	1.2 Max		
Nominal Gain	25 dBi		

Mechanical & Product Information

Product Number	RWHA90-25, P-Grade	Product Type	Standard Gain Horn Antenna
Waveguide	WR90(BJ100), FBP100(UBR) Flange	Waveguide Body	Aluminum, Light blue painted
Dimensions	740(L)*250(W)*180(H)mm	Net Weight	-