

WR75 Standard Gain Horn Antenna, RWHA75-15 9.84-15GHz, 15dB Nominal Gain, FBP120(UBR) Flange

Dimensions(mm) Tolerance $\pm 1\%$

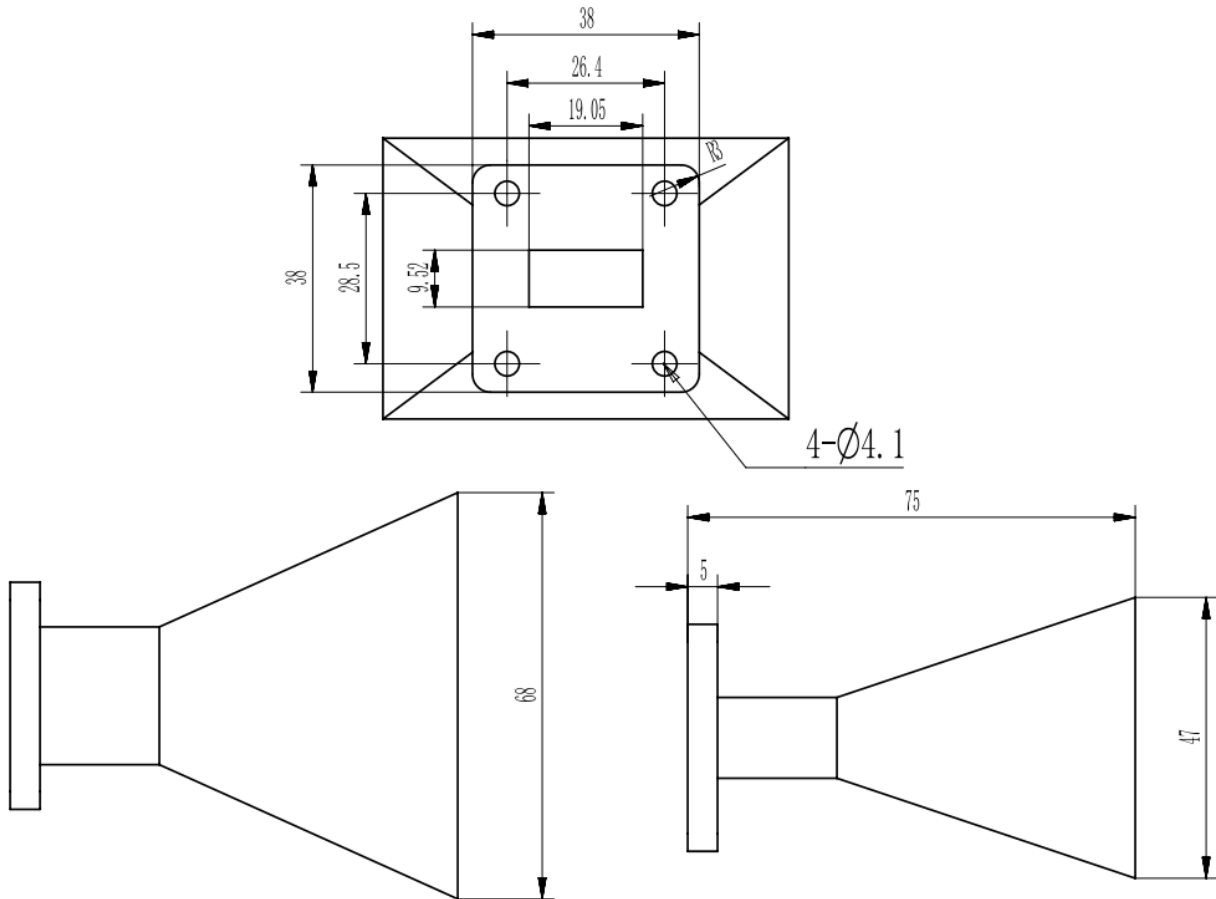

Electrical & Environmental

Frequency Range	9.84-15GHz	Impedance	50 Ohm
VSWR	1.2 Max		
Nominal Gain	15 dBi		

Mechanical & Product Information

Product Number	RWHA75-15, P-Grade	Product Type	Standard Gain Horn Antenna
Waveguide	WR75(BJ120), FBP120(UBR) Flange	Waveguide Body	Aluminum, Light blue painted
Dimensions	75(L)*68(W)*47(H)mm	Net Weight	-