

WR51 Standard Gain Horn Antenna, RWHA51-15
14.5-22GHz, 15dB Nominal Gain, FBP180(UBR) Flange

Dimensions(mm) Tolerance±1%

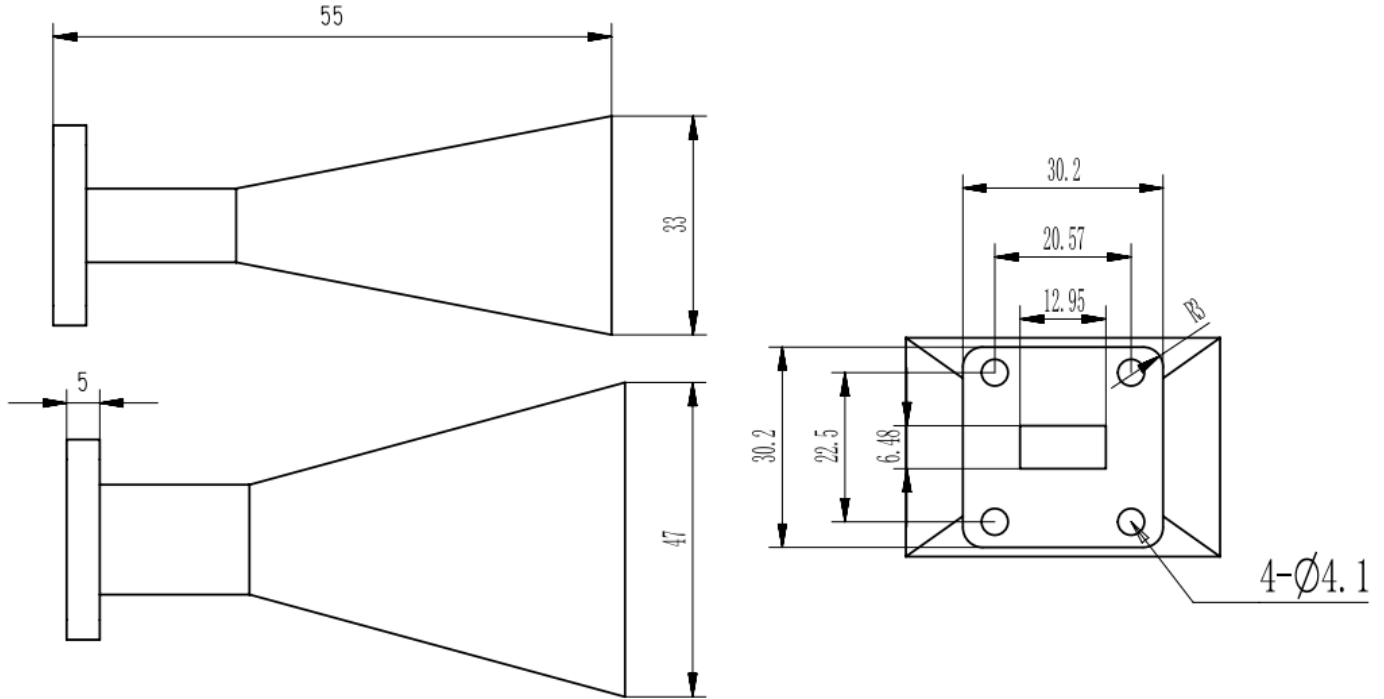

Electrical & Environmental

Frequency Range	14.5-22GHz	Impedance	50 Ohm
VSWR	1.2 Max		
Nominal Gain	15 dBi		

Mechanical & Product Information

Product Number	RWHA51-15, P-Grade	Product Type	Standard Gain Horn Antenna
Waveguide	WR51(BJ180), FBP180(UBR) Flange	Waveguide Body	Copper, Light blue painted
Dimensions	55(L)*47(W)*33(H)mm	Net Weight	-