

WR34 Standard Gain Horn Antenna, 2.92mm Female, RWHA34K-15
27.1-33GHz, 15dB Nominal Gain, FBP260(UBR) Flange, Right Angle

Dimensions(mm) Tolerance±1%

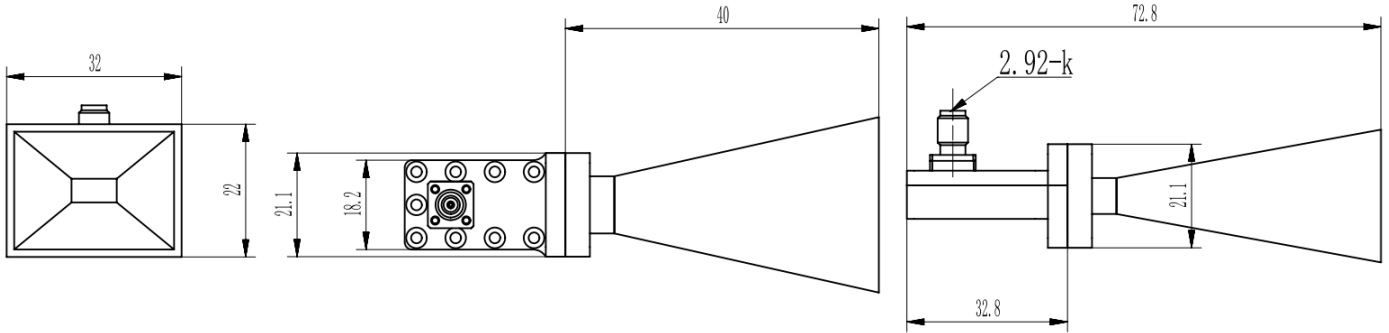

Electrical & Environmental

Frequency Range	27.1-33GHz	Impedance	50 Ohm
VSWR	1.3 Max		
Nominal Gain	15 dBi		

Mechanical & Product Information

Product Number	RWHA34K-15, P-Grade	Product Type	Standard Gain Horn Antenna
Connector	2.92mm Female, Right Angle	Connector Body	Passivated stainless steel
Waveguide	WR34(BJ260), FBP260(UBR) Flange	Waveguide Body	Copper, Light blue painted
Center Contact	Copper pickling		
Dimensions	72.8(L)*32(W)*22(H)mm	Net Weight	-