

WR34 Standard Gain Horn Antenna, RWHA34-15
27.1-33GHz, 15dB Nominal Gain, FBP260(UBR) Flange

Dimensions(mm) Tolerance±1%

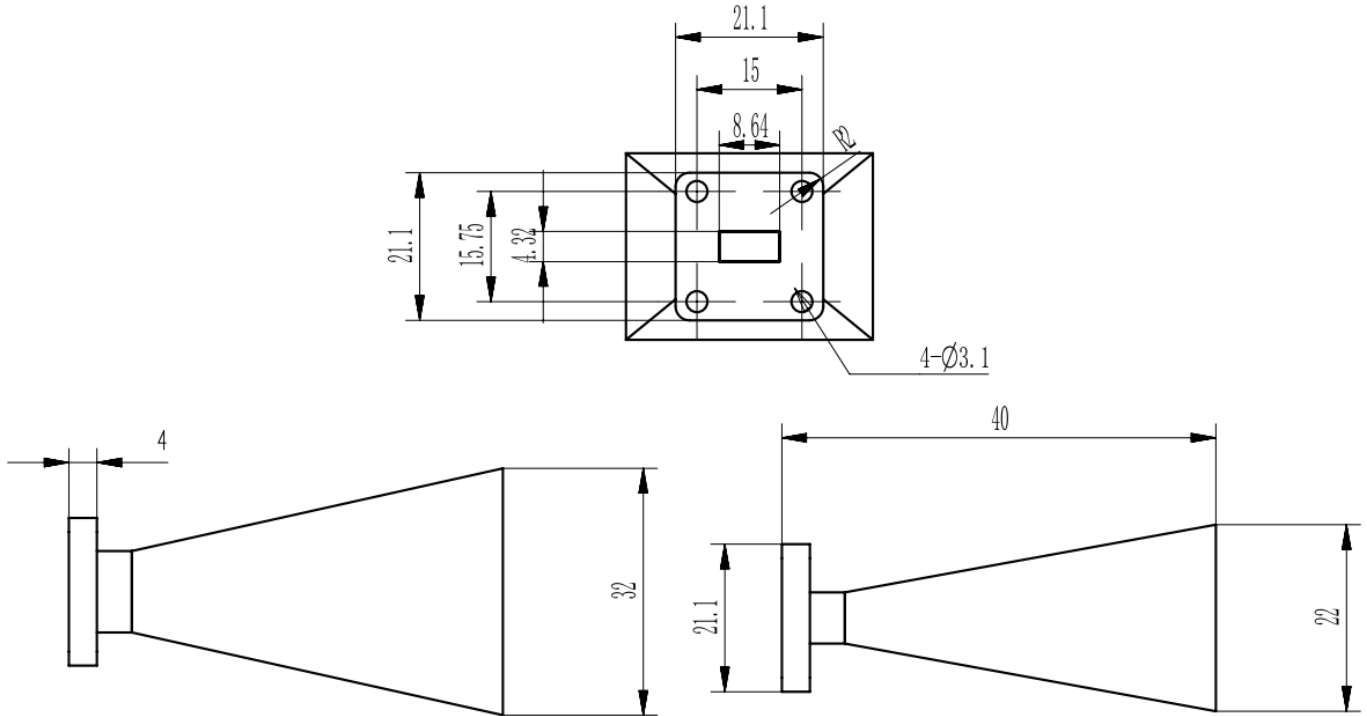

Electrical & Environmental

Frequency Range	27.1-33GHz	Impedance	50 Ohm
VSWR	1.2 Max		
Nominal Gain	15 dBi		

Mechanical & Product Information

Product Number	RWHA34-15, P-Grade	Product Type	Standard Gain Horn Antenna
Waveguide	WR34(BJ260), FBP260(UBR) Flange	Waveguide Body	Copper, Light blue painted
Dimensions	40(L)*32(W)*22(H)mm	Net Weight	-