

WR187 Standard Gain Horn Antenna, SMA Female, RWHA187S-20
3.94-5.99GHz, 20dB Nominal Gain, FDP48(UDR) Flange, Right Angle

Dimensions(mm) Tolerance±1%

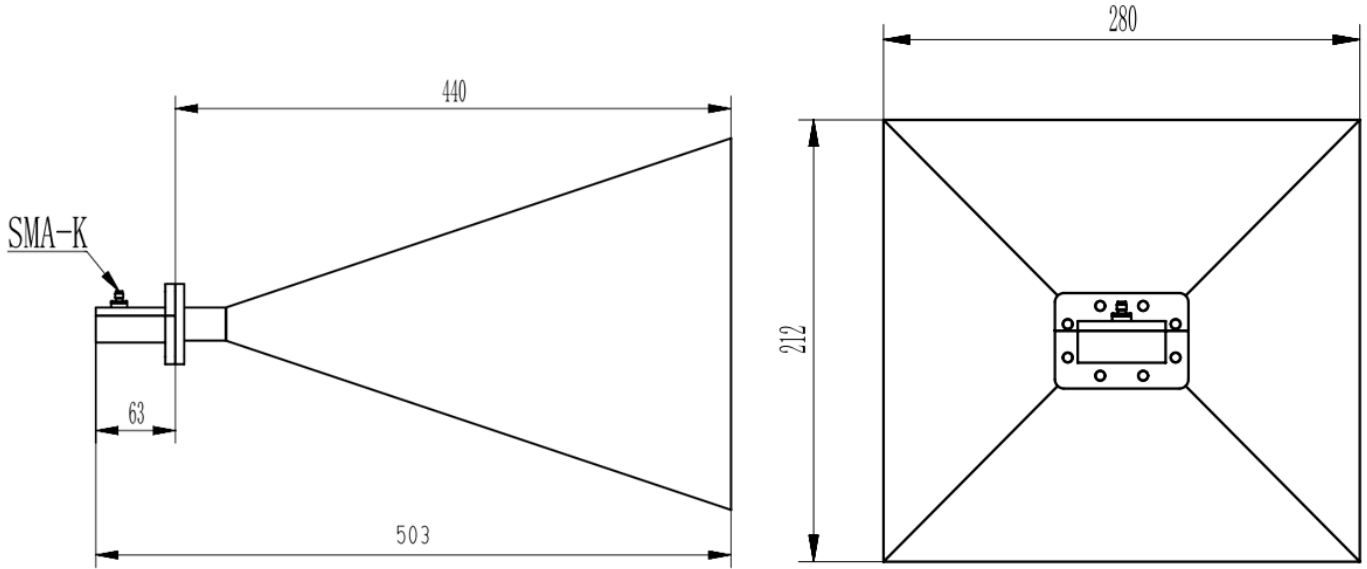

Electrical & Environmental

Frequency Range	3.94-5.99GHz	Impedance	50 Ohm
VSWR	1.3 Max		
Nominal Gain	20 dBi		

Mechanical & Product Information

Product Number	RWHA187S-20, P-Grade	Product Type	Standard Gain Horn Antenna
Connector	SMA Female, Right Angle	Connector Body	Passivated stainless steel
Waveguide	WR187(BJ48), FDP48(UDR) Flange	Waveguide Body	Aluminum, Light blue painted
Center Contact	Aluminum, electric conductive oxidation		
Dimensions	503(L)*280(W)*212(H)mm	Net Weight	-