

WR187 Standard Gain Horn Antenna, RWHA187-15
3.94-5.99GHz, 15dB Nominal Gain, FDP48(UDR) Flange

Dimensions(mm) Tolerance±1%

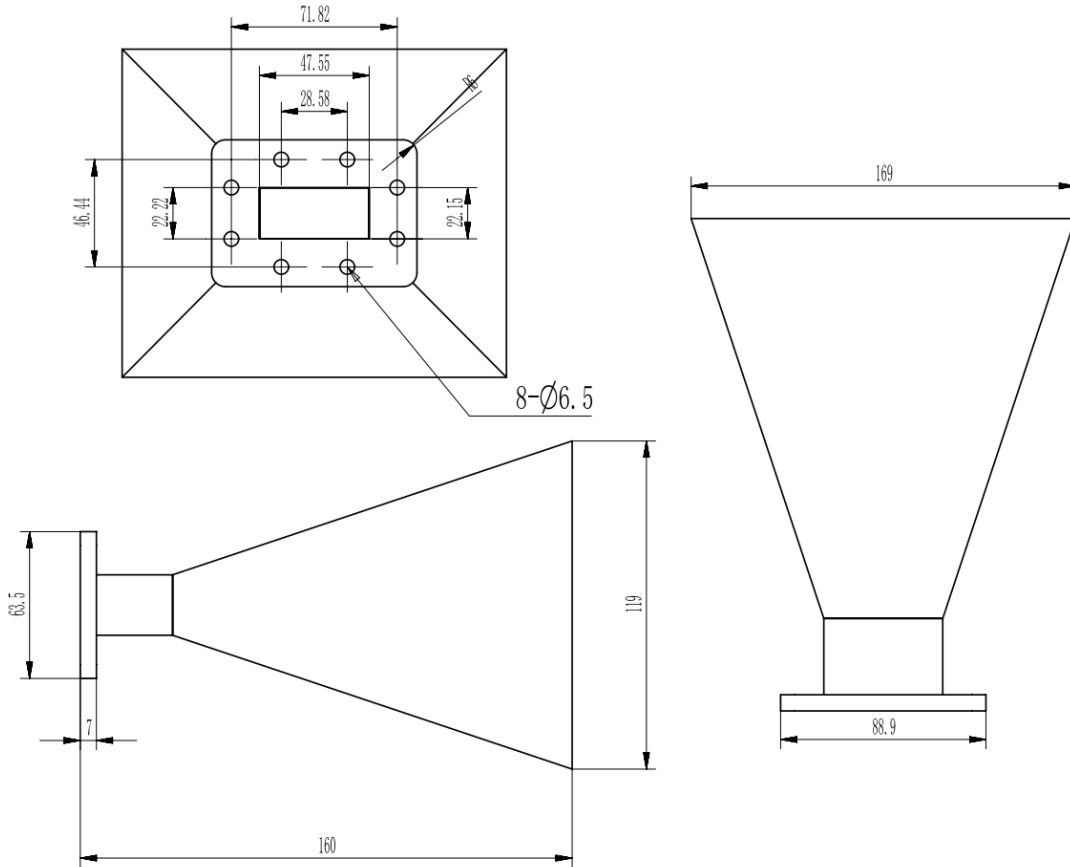

Electrical & Environmental

Frequency Range	3.94-5.99GHz	Impedance	50 Ohm
VSWR	1.2 Max		
Nominal Gain	15 dBi		

Mechanical & Product Information

Product Number	RWHA187-15, P-Grade	Product Type	Standard Gain Horn Antenna
Waveguide	WR187(BJ48), FDP48(UDR) Flange	Waveguide Body	Aluminum, Light blue painted
Dimensions	160(L)*169(W)*119(H)mm	Net Weight	-