

WR187 Standard Gain Horn Antenna, RWHA187-10
3.94-5.99GHz, 10dB Nominal Gain, FDP48(UDR) Flange

Dimensions(mm) Tolerance±1%

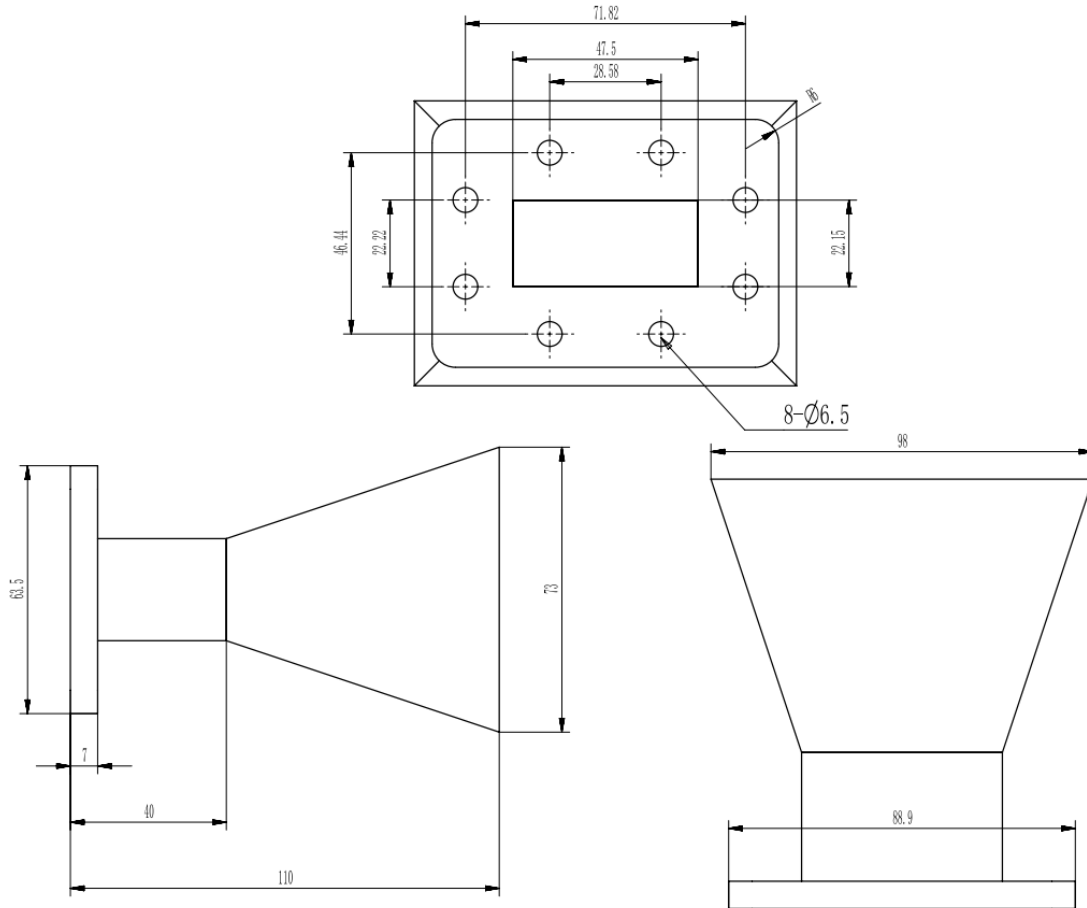

Electrical & Environmental

Frequency Range	3.94-5.99GHz	Impedance	50 Ohm
VSWR	1.25 Max		
Nominal Gain	10 dBi		

Mechanical & Product Information

Product Number	RWHA187-10, P-Grade	Product Type	Standard Gain Horn Antenna
Waveguide	WR187(BJ48), FDP48(UDR) Flange	Waveguide Body	Aluminum, Light blue painted
Dimensions	110(L)*98(W)*73(H)mm	Net Weight	-