

WR15 Standard Gain Horn Antenna, 1.85mm Female, RWHA15V-20
49.8-75.8GHz, 20dB Nominal Gain, FUGP620 Circular Flange, Right Angle

Dimensions(mm) Tolerance±1%

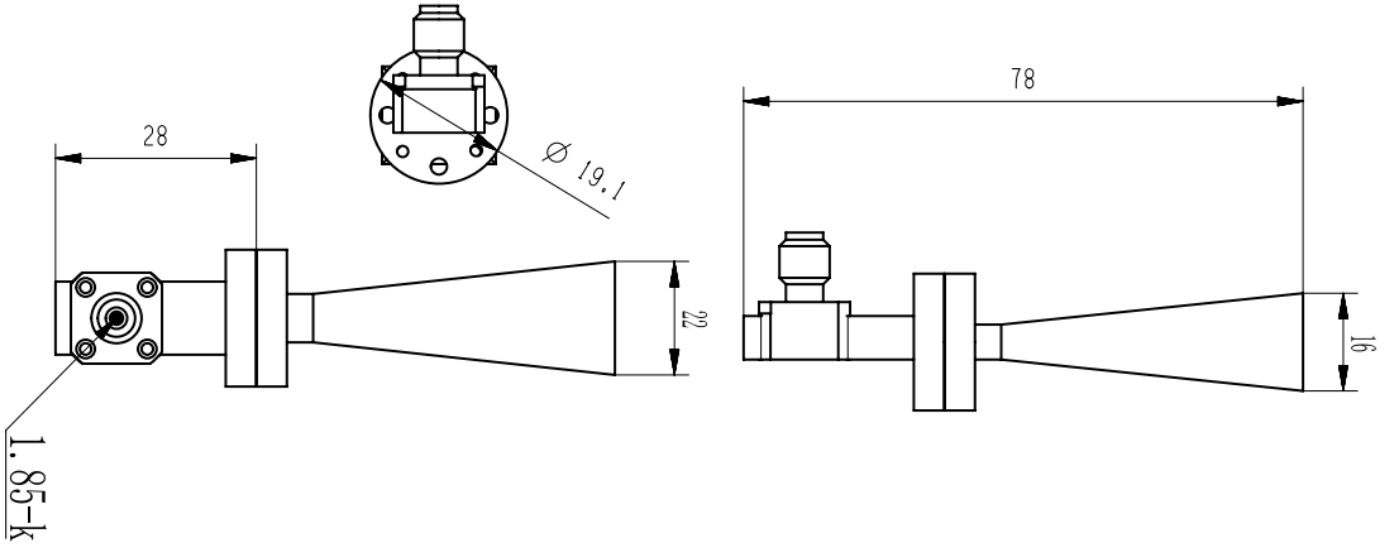

Electrical & Environmental

Frequency Range	49.8-75.8GHz	Impedance	50 Ohm
VSWR	1.5 Max		
Nominal Gain	20 dBi		

Mechanical & Product Information

Product Number	RWHA15V-20, P-Grade	Product Type	Standard Gain Horn Antenna
Connector	1.85mm Female, Right Angle	Connector Body	Passivated stainless steel
Waveguide	WR15(BJ620), FUGP620 Circular Flange	Waveguide Body	Copper, gold plated
Center Contact	Copper, gold plated		
Dimensions	78(L)*22(W)*16(H)mm	Net Weight	-



Microwave and Millimeter wave products
supplier

RFTOP® Technology Co., Ltd.
www.rftop.com service@rftop.com 86-755-88840350