

WR159 Standard Gain Horn Antenna, RWHA159-10 4.64-7.05GHz, 10dB Nominal Gain, FDP58(UDR) Flange

Dimensions(mm) Tolerance $\pm 1\%$

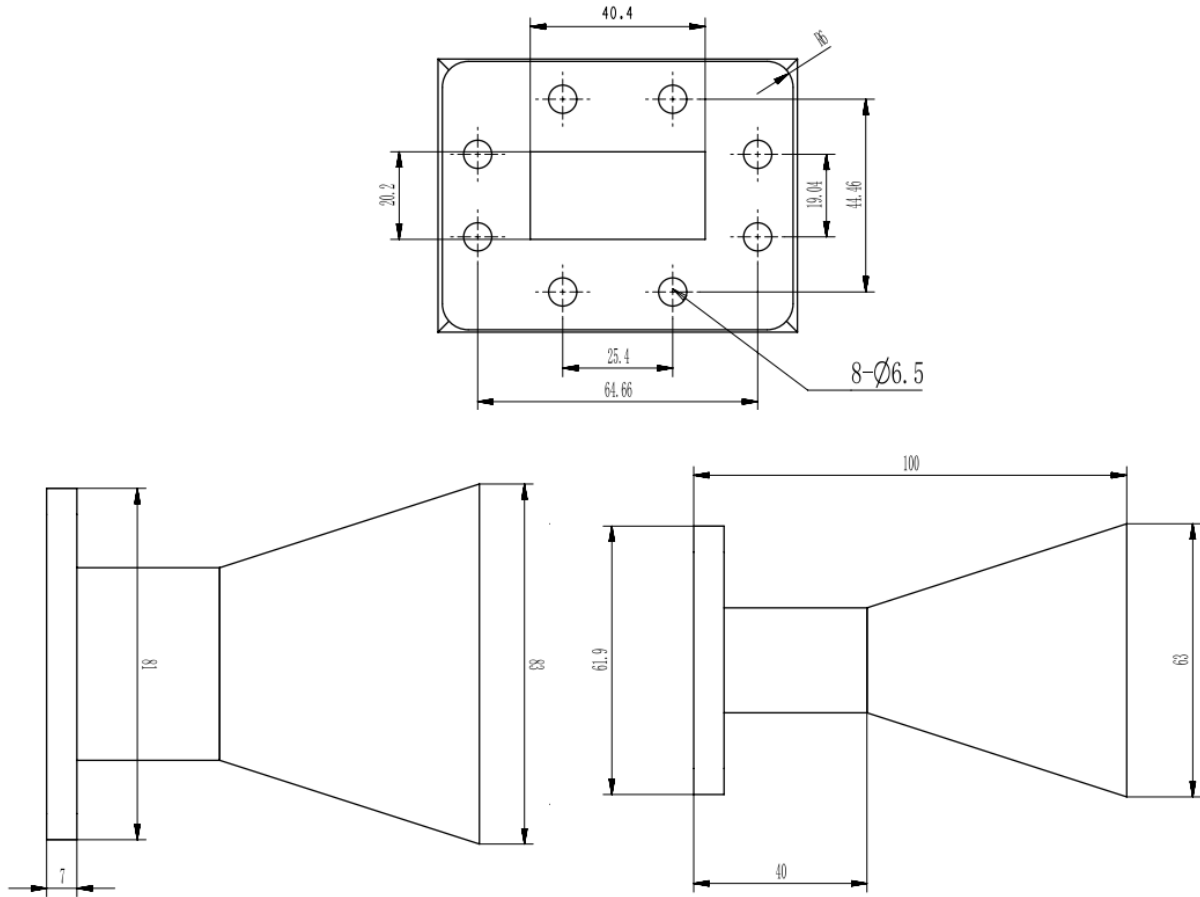

Electrical & Environmental

Frequency Range	4.64-7.05GHz	Impedance	50 Ohm
VSWR	1.25 Max		
Nominal Gain	10 dBi		

Mechanical & Product Information

Product Number	RWHA159-10, P-Grade	Product Type	Standard Gain Horn Antenna
Waveguide	WR159(BJ58), FDP58(UDR) Flange	Waveguide Body	Aluminum, Light blue painted
Dimensions	100(L)*83(W)*63(H)mm	Net Weight	-