

WR15 Standard Gain Horn Antenna, RWHA15-25 49.8-75.8GHz, 25dB Nominal Gain, FUGP620 Circular Flange

Dimensions(mm) Tolerance $\pm 1\%$

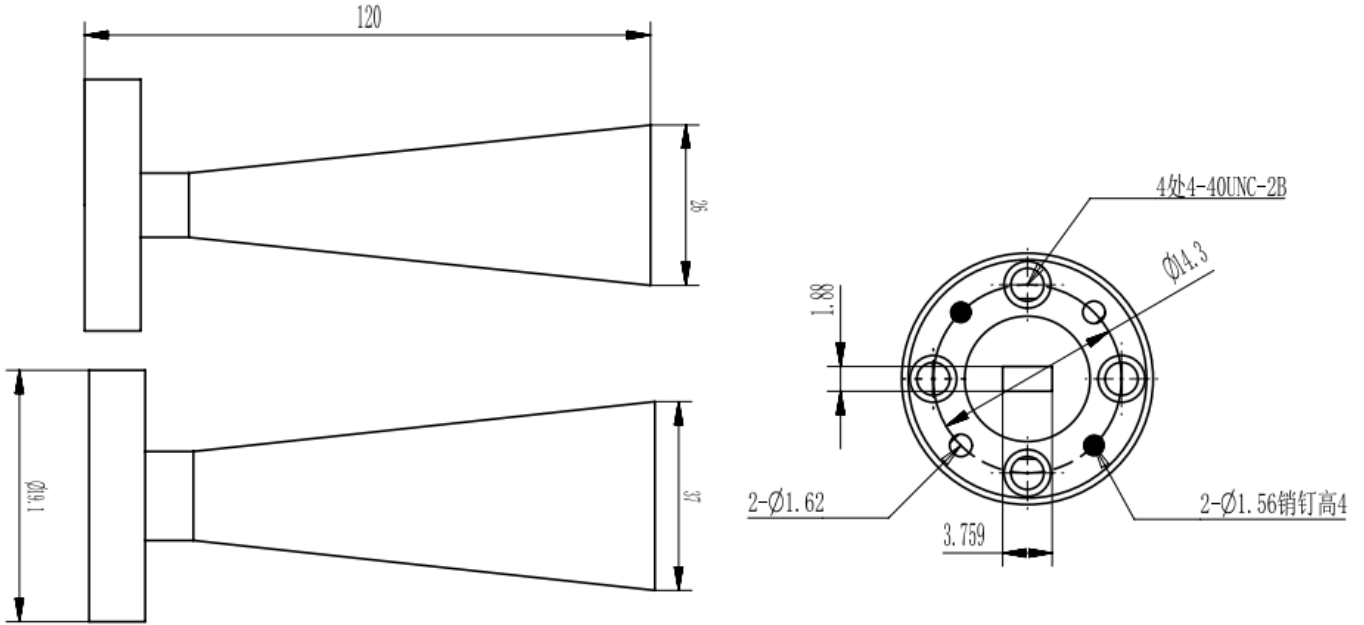

Electrical & Environmental

Frequency Range	49.8-75.8GHz	Impedance	50 Ohm
VSWR	1.2 Max		
Nominal Gain	25 dBi		

Mechanical & Product Information

Product Number	RWHA15-25, P-Grade	Product Type	Standard Gain Horn Antenna
Waveguide	WR15(BJ620), FUGP620 Circular Flange	Waveguide Body	Copper, gold plated
Dimensions	120(L)*37(W)*26(H)mm	Net Weight	-