

WR15 Standard Gain Horn Antenna, RWHA15-20
49.8-75.8GHz, 20dB Nominal Gain, FUGP620 Circular Flange

Dimensions(mm) Tolerance±1%

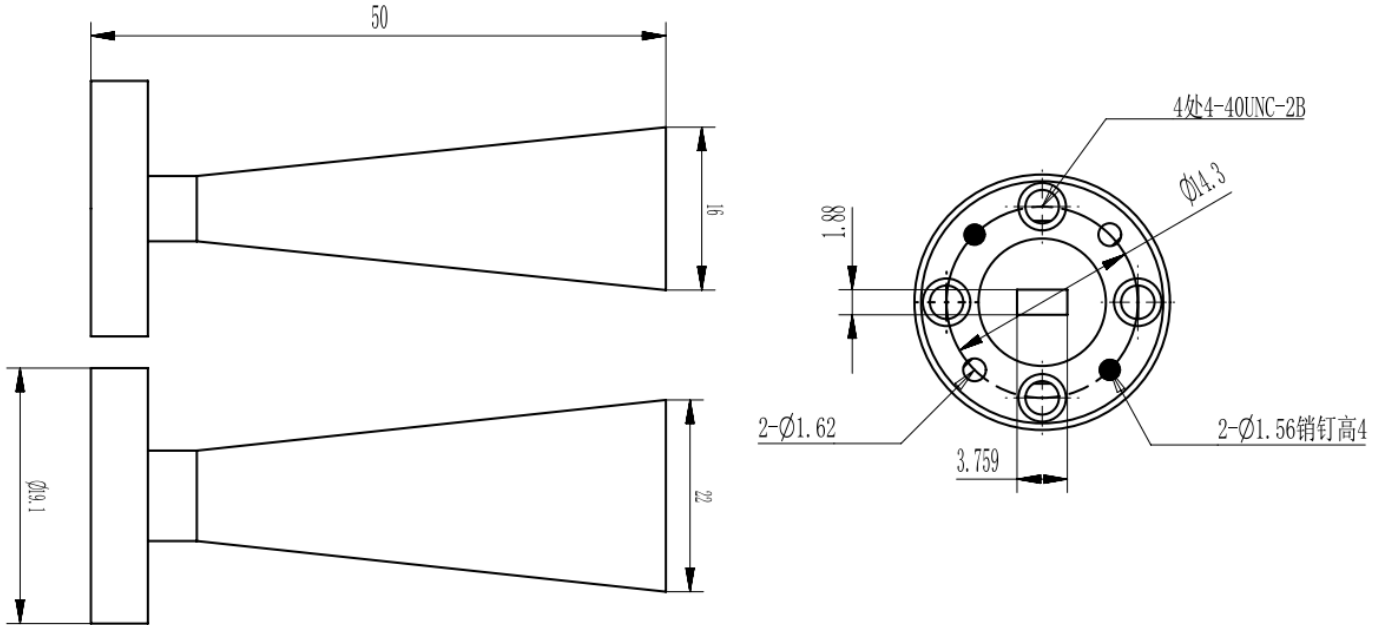

Electrical & Environmental

Frequency Range	49.8-75.8GHz	Impedance	50 Ohm
VSWR	1.2 Max		
Nominal Gain	20 dBi		

Mechanical & Product Information

Product Number	RWHA15-20, P-Grade	Product Type	Standard Gain Horn Antenna
Waveguide	WR15(BJ620), FUGP620 Circular Flange	Waveguide Body	Copper, gold plated
Dimensions	50(L)*22(W)*16(H)mm	Net Weight	-