

WR137 Standard Gain Horn Antenna, SMA Female, RWHA137S-10
5.38-8.17GHz, 10dB Nominal Gain, FDP70(UDR) Flange, Right Angle

Dimensions(mm) Tolerance±1%

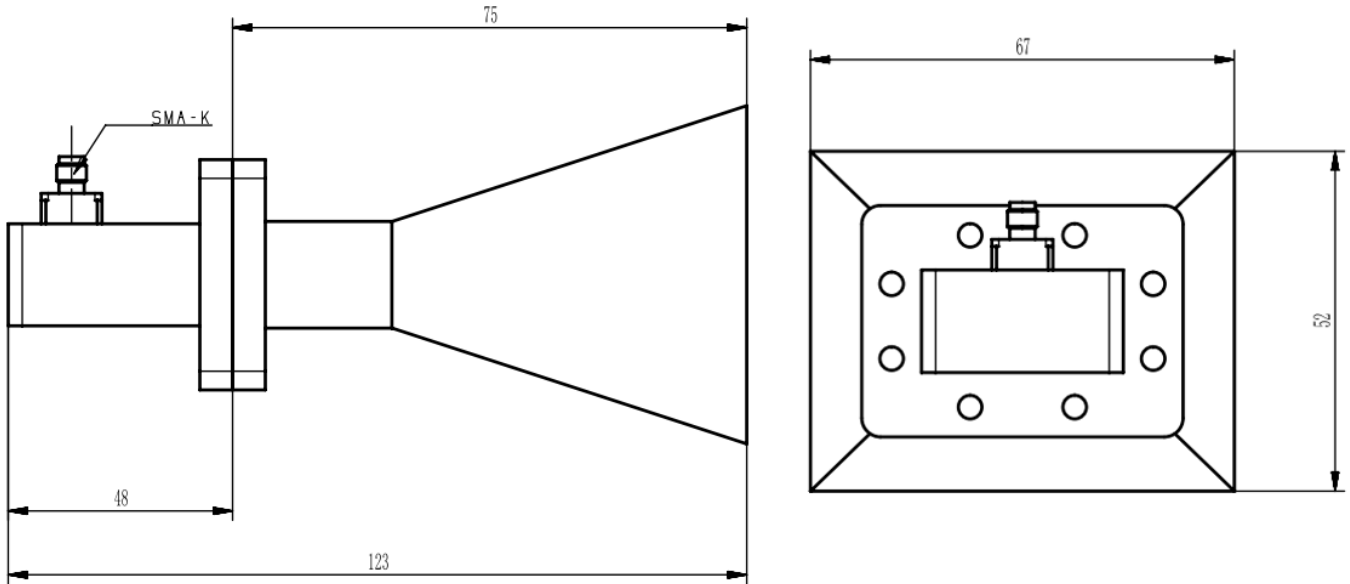

Electrical & Environmental

Frequency Range	5.38-8.17GHz	Impedance	50 Ohm
VSWR	1.4 Max		
Nominal Gain	10 dBi		

Mechanical & Product Information

Product Number	RWHA137S-10, P-Grade	Product Type	Standard Gain Horn Antenna
Connector	SMA Female, Right Angle	Connector Body	Passivated stainless steel
Waveguide	WR137(BJ70), FDP70(UDR) Flange	Waveguide Body	Aluminum, Light blue painted
Center Contact	Aluminum, electric conductive oxidation		
Dimensions	123(L)*67(W)*52(H)mm	Net Weight	-