

WR137 Standard Gain Horn Antenna, RWHA137-15
5.38-8.17GHz, 15dB Nominal Gain, FDP70(UDR) Flange

Dimensions(mm) Tolerance±1%

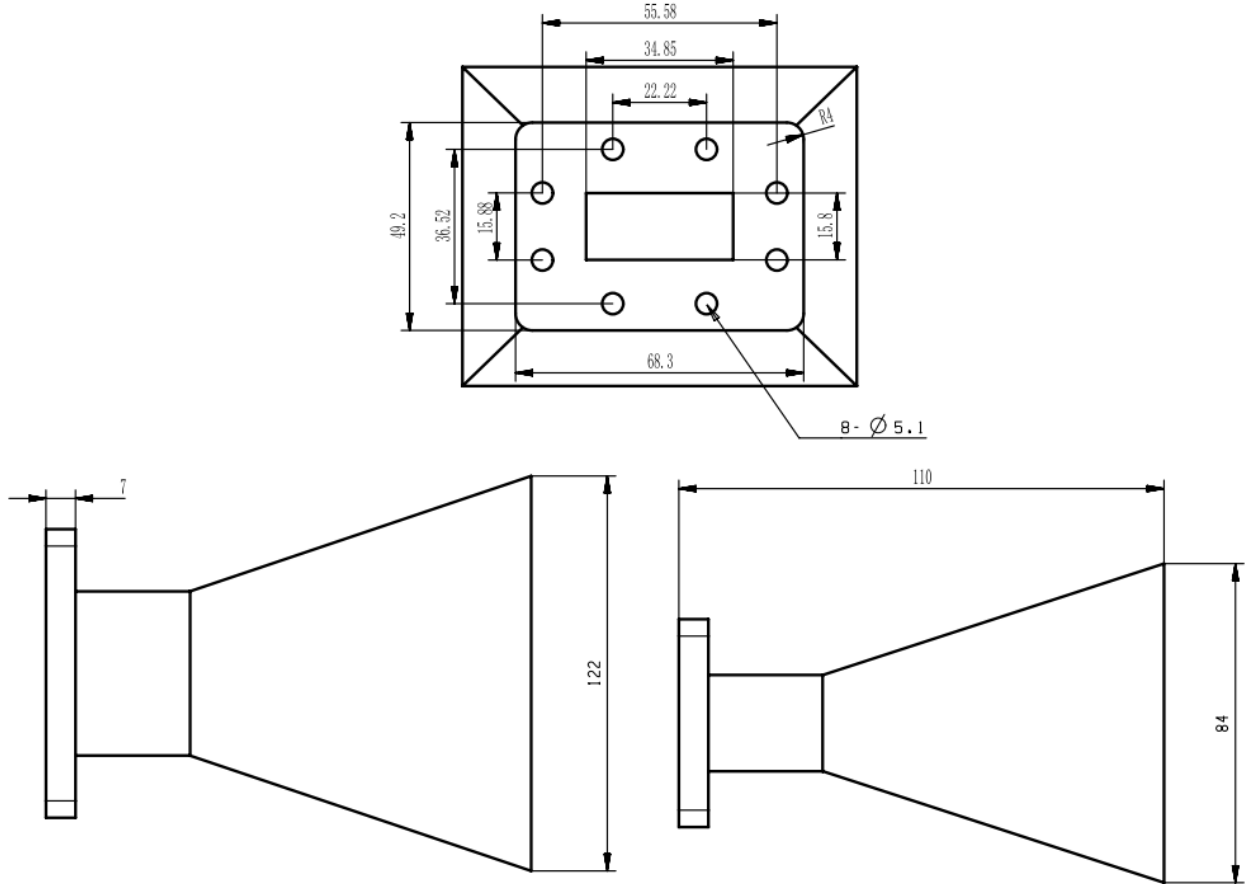

Electrical & Environmental

Frequency Range	5.38-8.17GHz	Impedance	50 Ohm
VSWR	1.2 Max		
Nominal Gain	15 dBi		

Mechanical & Product Information

Product Number	RWHA137-15, P-Grade	Product Type	Standard Gain Horn Antenna
Waveguide	WR137(BJ70), FDP70(UDR) Flange	Waveguide Body	Aluminum, Light blue painted
Dimensions	110(L)*122(W)*84(H)mm	Net Weight	-