

WR137 Standard Gain Horn Antenna, RWHA137-10
5.38-8.17GHz, 10dB Nominal Gain, FDP70(UDR) Flange

Dimensions(mm) Tolerance±1%

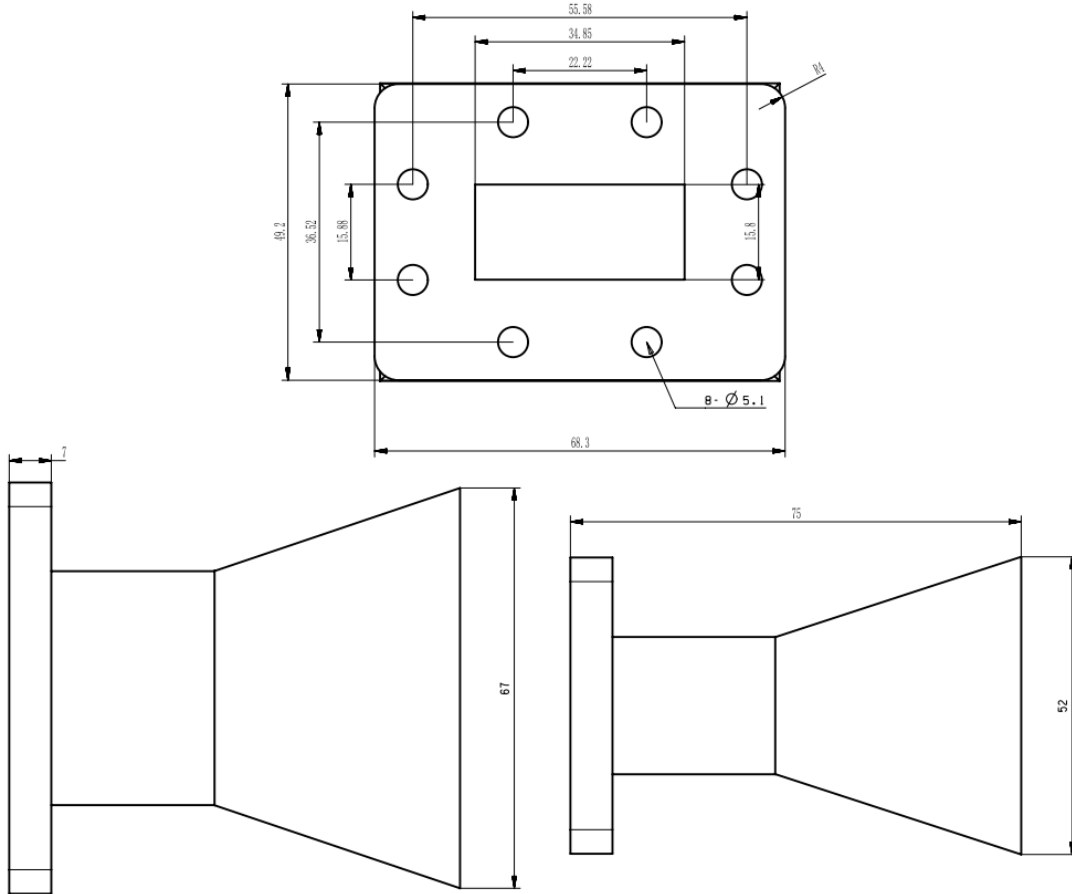

Electrical & Environmental

Frequency Range	5.38-8.17GHz	Impedance	50 Ohm
VSWR	1.25 Max		
Nominal Gain	10 dBi		

Mechanical & Product Information

Product Number	RWHA137-10, P-Grade	Product Type	Standard Gain Horn Antenna
Waveguide	WR137(BJ70), FDP70(UDR) Flange	Waveguide Body	Aluminum, Light blue painted
Dimensions	75(L)*67(W)*52(H)mm	Net Weight	-