

WR112 Standard Gain Horn Antenna, RWHA112-15 6.57-9.99GHz, 15dB Nominal Gain, FBP84(UBR) Flange

Dimensions(mm) Tolerance $\pm 1\%$

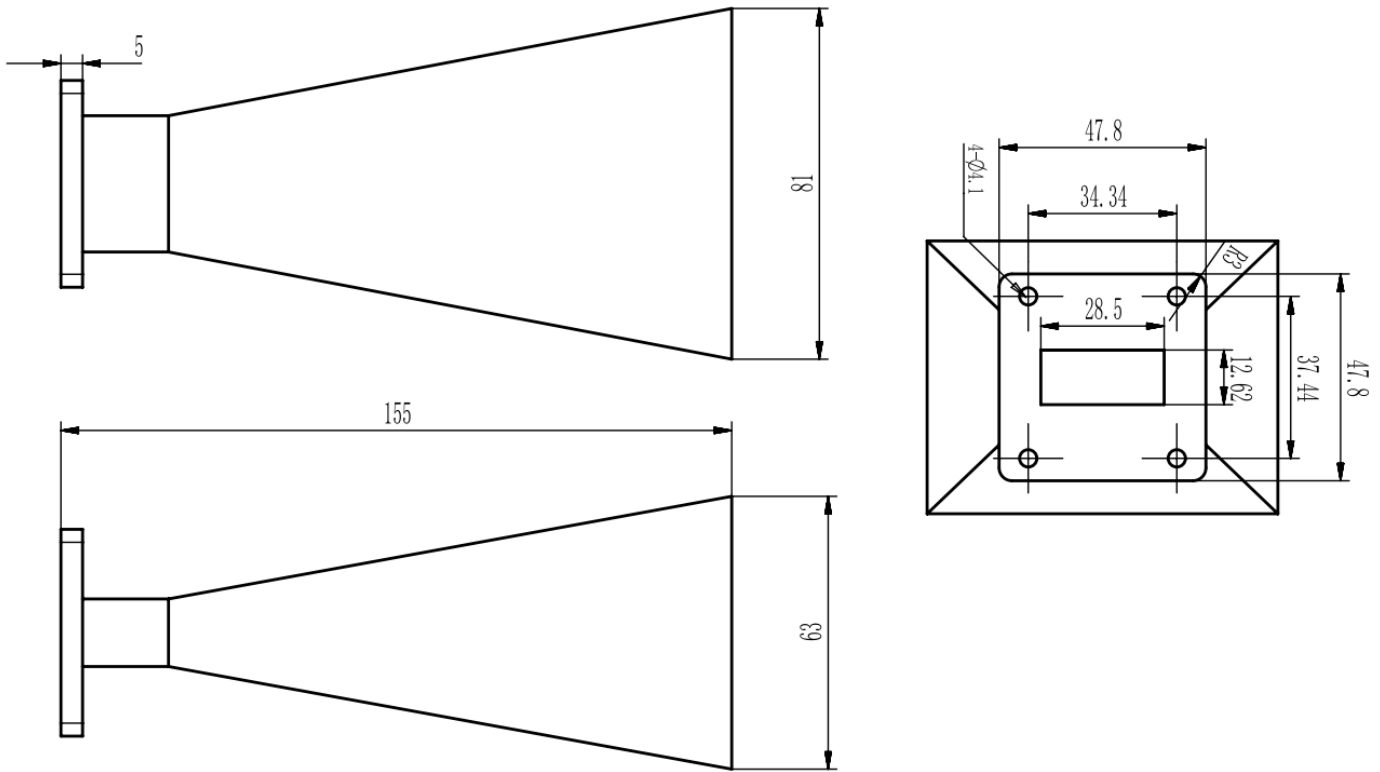

Electrical & Environmental

Frequency Range	6.57-9.99GHz	Impedance	50 Ohm
VSWR	1.2 Max		
Nominal Gain	15 dBi		

Mechanical & Product Information

Product Number	RWHA112-15, P-Grade	Product Type	Standard Gain Horn Antenna
Waveguide	WR112(BJ84), FBP84(UBR) Flange	Waveguide Body	Aluminum, Light blue painted
Dimensions	155(L)*81(W)*63(H)mm	Net Weight	-