

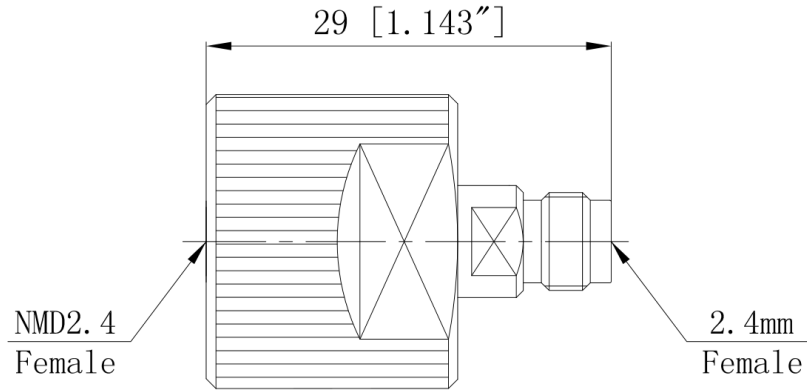

NMD2.4 Female to 2.4mm Female, Adapter, RA5022 DC-50GHz, Straight

Dimensions(mm) Tolerance $\pm 1\%$



Electrical & Environmental

Frequency Range	DC-50GHz	Impedance	50 ohm
VSWR	1.3 max	Operating Temp	-55°C to +165°C
Insertion Loss	0.40dB max		

Mechanical & Product Information

Product Number	RA5022, E-Grade, NMD Series	Connector	NMD2.4 Female to 2.4mm Female
Connector Body	Passivated stainless steel	Shape/Mounting	Straight, None
Center Contact	Gold plated beryllium copper	Insulator	PEI

Typical Test Data

