

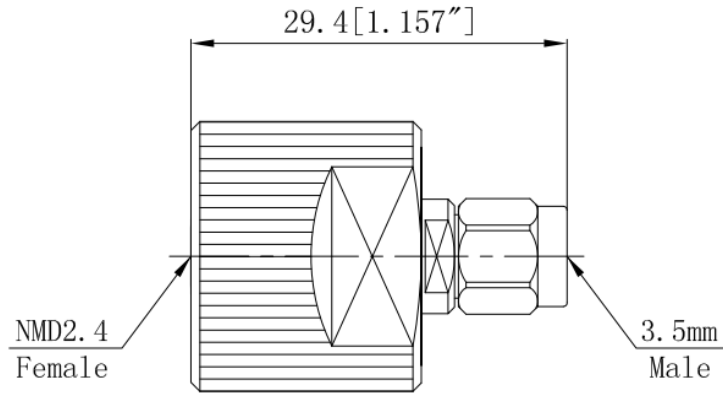

NMD2.4 Female to 3.5mm Male, Adapter, RA3426 DC-33GHz, Straight

Dimensions(mm) Tolerance \pm 1%



Electrical & Environmental

Frequency Range	DC-33GHz	Impedance	50 ohm
VSWR	1.2 max	Operating Temp	-55°C to +165°C
Insertion Loss	0.40dB max		

Mechanical & Product Information

Product Number	RA3426, E-Grade, NMD Series	Connector	NMD2.4 Female to 3.5mm Male
Connector Body	Passivated stainless steel	Shape/Mounting	Straight, None
Center Contact	Gold plated beryllium copper	Insulator	PEI

Typical Test Data

