

3.5mm Female to 3.5mm Female, Adapter, RA3401F-4 DC-33GHz, Straight, 4 hole flange

Dimensions(mm) Tolerance $\pm 1\%$

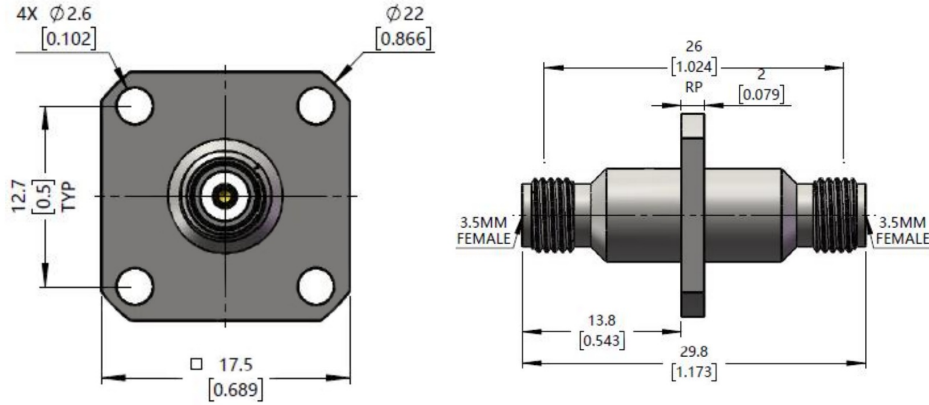

Electrical & Environmental

Frequency Range	DC-33GHz	Impedance	50 ohm
VSWR	1.2 max	Operating Temp	-55°C to +165°C
Insertion Loss	0.28dB max		

Mechanical & Product Information

Product Number	RA3401F-4, JP-Grade	Connector	3.5mm Female to 3.5mm Female
Connector Body	Passivated stainless steel	Shape/Mounting	Straight, 4 hole flange
Center Contact	Gold plated beryllium copper	Insulator	PEI