

N Male to SMA Female, Adapter, RA18N17-3 DC-18GHz, Straight

Dimensions(mm) Tolerance $\pm 1\%$

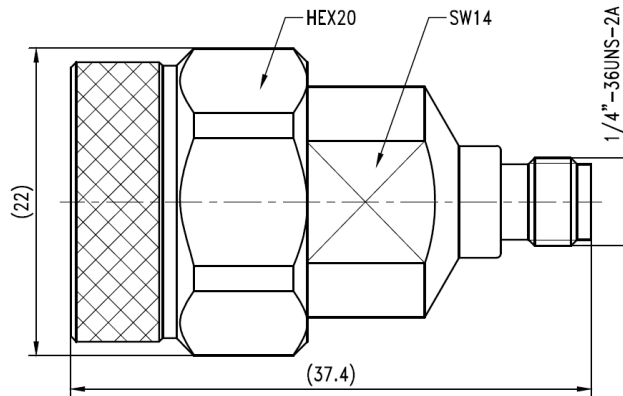

Electrical & Environmental

Frequency Range	DC-18GHz	Impedance	50 ohm
VSWR	1.15 max	Operating Temp	-55°C to +165°C

Mechanical & Product Information

Product Number	RA18N17-3, JP-Grade	Connector	N Male to SMA Female
Connector Body	Passivated stainless steel 316F	Shape/Mounting	Straight, None
Center Contact	1.27um gold plated beryllium copper	Insulator	PEI&PTFE

