

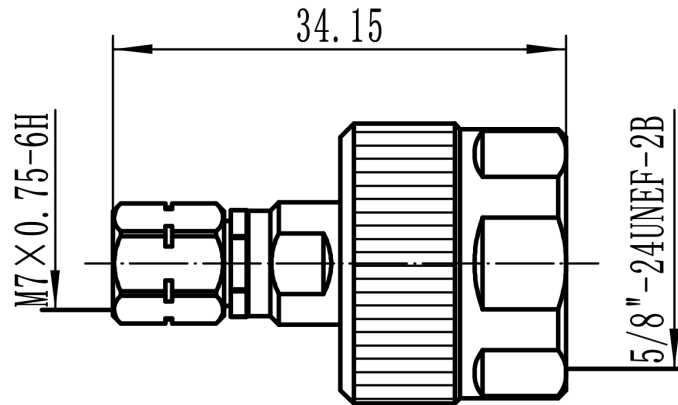

N Male to 2.4mm Male, Adapter, RA18N12 DC-18GHz, Straight

Dimensions(mm) Tolerance $\pm 1\%$



Electrical & Environmental

Frequency Range	DC-18GHz	Impedance	50 ohm
VSWR	1.15 max	Operating Temp	-55°C to +165°C
Insertion Loss	0.18dB max , Typ 0.15dB		

Mechanical & Product Information

Product Number	RA18N12, H-Grade	Connector	N Male to 2.4mm Male
Connector Body	Passivated stainless steel	Shape/Mounting	Straight, None
Center Contact	Gold plated beryllium copper	Insulator	PEI

Typical Test Data

